

INITIAL ENVIRONMENT ASSESSMENT REPORT(IEAR) FOR TRANSMISSION NETWORK IN GUMTI & SOUTH TRIPURA DISTRICT UNDER NERPSIP TRANCHE-1, TRIPURA



Prepared By

ENVIRONMENT AND SOCIAL MANAGEMENT
POWER GRID CORPORATION OF INDIA LTD
(A GOVERNMENT OF INDIA ENTERPRISE)

For



TRIPURA STATE ELECTRICITY CORPORATION LIMITED
(A GOVERNMENT OF TRIPURA ENTERPRISE)

CONTENTS

SECTION	DESCRIPTION	Page No.
SECTION - I	: PROJECT DESCRIPTION	- 1-4
	- Background	- 1
	- Benefits of the Project	- 2
	- Project Justification	- 2
	- Project Highlights	- 3
	- Project Scope & Present Study	- 3
SECTION - II	: BASE LINE DATA	- 5-8
	- Tripura	- 5
	- Ecological Resources	- 6
	- Protected Areas	- 7
	- Human and Economic Development	- 7
SECTION- III	: POLICY, LEGAL & REGULATORY FRAMEWORK	- 9-14
	- Environmental	- 9
	- Constitutional Provisions	- 9
	- Mandatory Requirements	- 10
	- Funding Agency	- 12
	- Social	- 13
	- Constitutional Provisions	- 13
	- Mandatory Requirements	- 13
	- Funding Agency	- 14
SECTION- IV	: APPROACH FOR ROUTE/SITE SELECTION	- 15 -24
	- Route Selection Criteria	- 15
	- Study of Alternatives	- 15
	- Evaluation of Alternatives Route Alignment for 132 kV D/C Udaipur – Bagafa Transmission Line	- 16
	- Evaluation of Alternatives Route Alignment for 132 kV D/C Udaipur – Amarpur Transmission Line	- 18
	- Evaluation of Alternatives Route Alignment for 132 kV D/C Bagafa – Satchand Transmission Line	- 19
	- Evaluation of Alternatives Route Alignment for 132 kV D/C Bagafa – Belonia Transmission Line	- 21
	- Evaluation of Alternatives Route Alignment for 132 kV D/C Belonia – Sabroom Transmission Line	- 22
	- Substation	- 24
SECTION - V	: POTENTIAL ENVIRONMENTAL IMPACTS, THEIR EVALUATION & MANAGEMENT	- 25-36
	- Impact due to Project Location & Design	- 25
	- Environmental Problem due to Design	- 29
	- Environmental Problems during Construction Phase	- 31
	- Environmental Problems Resulting from Operation	- 33
	- Critical Environmental Review Criteria	- 34
	- Public consultation	- 35
	- Conclusion	- 36
SECTION- VI	: PROJECT IMPLEMENTATION ARRANGEMENT & MONITORING	- 37-56
	- Administrative Arrangement for Project Implementation	- 37
	- Review of Implementation Progress	- 37
	- Environmental Monitoring in Utility	- 38
	- Grievance Redress Mechanism	- 39
	- Environmental Review	- 40

LIST OF ENCLOSURES

Sr. No.	Annexure/ Exhibit/ Map/ Figure/Plate	Description
Annexure		
1	Annexure -1	National Park and Wildlife Sanctuaries in Tripura
2	Annexure- 2	Substation Land Details
3	Annexure -3	Tree / crop/ tower footing compensation process
4	Annexure -4	Conservation Status of Important Fauna of Trishna Wildlife Sanctuary
5	Annexure -5	Safety Plan
6	Annexure -6	Safety Conditions in Contract Document
7	Annexure -7	Health & Safety Checklist
8	Annexure -8	Public Consultation Notice
9	Annexure -9	Minutes of Meeting & Attendance sheet of Public Consultation Meeting
10	Annexure -10	Contents of FEAR
11	Annexure -11	Estimated Budget
Exhibit		
12	Exhibit -1	Power map of Tripura
13	Exhibit -2	Schematic Map Showing Proposed Transmission Network
14	Exhibit -3	TSECL Organization Support Structure
Figure		
15	Figure -1	132 kV line Depicting actual position along with RoW and extent of damage
16	Figure- 1a	132 kV Tower base showing impact on agricultural land and crop
17	Figure -2	Typical Plan of Transmission line Tower footing indicating the above position and extent of damage
18	Figure -3	Tree Felling Pattern in Forest in 132 kV D/C
19	Figure -3a	Schematic Diagram indicating area of influence/impact for 132 kV D/C transmission line
20	Figure- 4	Diagram of 132 KV D/C Tower Design
Map		
21	Map -1	Forest Cover Map of Tripura
22	Map- 2	Alternatives Route Alignment for 132 kV D/C Udaipur –Bagafa Tr. Line
23	Map -3	IBAT Map superimposing for 132 kV D/C Udaipur –Bagafa Tr. Line
24	Map- 3a	Geospatial map of area showing Sanctuary boundary and Bison Reserve vis-à-vis 132 kV D/C Udaipur –Bagafa line route
25	Map -4	Alternatives Route Alignment for 132 kV D/C Udaipur- Amarpur Tr. Line
26	Map- 5	Alternatives Route Alignment for 132 kV D/C Bagafa –Satchand Tr. Line
27	Map- 6	Alternatives Route Alignment for 132 kV D/C Bagafa –Belonia Tr. Line
28	Map -7	Alternatives Route Alignment for 132 kV D/C Belonia --Sabroom Tr. Line
Plate		
29	Plate- 1	Photographs of Public Consultation Meeting

SECTION – I : PROJECT DESCRIPTION

1.0 BACKGROUND:

The North Eastern Region (NER) in India is endowed with rich energy resources but faces significant bottlenecks in electricity access and availability levels. The per capita power consumption in NER is one-third of the national average. No significant generation capacity has been added between 2004 and 2011 as a result of which inadequate power supply remains a critical constraint to sustainable and inclusive growth, and to scaling up private investment and economic competitiveness in the NER.

The road-map for development of power sector specifying the need for strengthening of overall Transmission, Sub-transmission system of NER and Sikkim was brought out in the “Pasighat Proclamation on Power” released during the first Sectoral Summit of North Eastern Council at Pasighat in Arunachal Pradesh in January 2007.

Pursuant to recommendations of Pasighat summit, a Sub-Group was constituted under the Chairmanship of Member (Power System), Central Electricity Authority (CEA) on Transmission, Sub-transmission related issues in North Eastern Region. The sub-group submitted its report in December, 2007 wherein a comprehensive scheme for strengthening of transmission, sub-transmission system was evolved by CEA in consultation with POWERGRID and States of North Eastern Region and Sikkim.

Subsequently, a number of meetings took place regarding methodology for execution and funding of the scheme. In the meeting taken by Member, Planning Commission on February 24, 2009 and meeting of Committee of PIB chaired by Secretary, Department of Expenditure on March 24, 2009, it was decided that DPRs of the scheme comprising transmission, sub-transmission system should be prepared by POWERGRID. Accordingly, DPRs for strengthening of transmission, sub-transmission system in Tripura were prepared and submitted to Ministry of DONER / Ministry of Power / TSECL by POWERGRID.

Among the NER States and Sikkim, the project in Arunachal Pradesh and Sikkim is proposed to be funded by Govt. of India. Implementation of the scheme in other 6 States in NER viz. Assam, Meghalaya, Tripura, Mizoram, Manipur & Nagaland is proposed through funding from World Bank / Govt. of India. The scheme is proposed to be funded by World Bank in three tranches. Accordingly, priority transmission, distribution schemes to be taken up under tranche-1 of the World Bank fund has been finalized by CEA in consultation with the State and POWERGRID.

Ministry of Power (MoP), GoI has appointed POWERGRID as Design cum Implementation Supervision Consultant (i.e. Project Management Consultant-PMC) and now redesignated as Implementing Agency (IA) to six North Eastern States for the said project. However, the ownership of the assets shall be with the respective State government or State Utilities, which upon progressive commissioning shall be handed over to them for taking care of Operation and Maintenance of assets.

1.1 BENEFITS OF THE PROJECT:

The proposed transmission & distribution schemes not only improve overall power supply situation but also improve reliability, quality, security and enhancement of power supply in the State.

1.2 PROJECT JUSTIFICATION

The State of Tripura is spread over an area of about 10,492 sq. km with a population of more than 37 Lakhs. The State of Tripura is endowed with rich energy resources but faces significant bottlenecks in electricity access and availability levels. The present per capita energy consumption is of the order of 335 units (kWh) against the regional per capita consumption of about 258 units and national per capita consumption of about 779 units. The State meets its power requirement through about 164.5 MW of self-generation and about 105 MW of power allocation from various central sector generation projects of NHPC and NEEPCO. The present demand is of the order of 250 MW. As most of the generation projects in the north eastern region are hydro in nature, the State faces shortage of power during low-hydro generation condition.

Presently, the State draws its share of power from central sector generating stations through following inter-state transmission system (ISTS):

- Agartala GPP – Agartala(Tripura) 132kV D/C
- Agartala GPP – Kumarghat(POWERGRID) 132 S/C
- Kumarghat(POWERGRID) – Aizwal(POWERGRID) 132kV S/C
- Kumarghat(POWERGRID) – Badarpur(POWERGRID) 132kV S/C
- Dharamanagar(Tripura) – Dullavcherra(Assam) 132kV S/C
- Pallatana(OTPC) – Silchar (POWERGRID) 400kV D/C
- Pallatana(OTPC)-Surajmaninagar(Tripura) 400kV D/C (initially operated at 132kV)

As per the 18th Electric Power Survey of CEA, the future demand of the State is expected to grow to about 340 MW by year 2016-17 and 472 MW by year 2021-22. This shall be met through various hydro and thermal projects coming up in the north-eastern region in near future, which are as follows:

- Pallatana GBPP : 726 MW
- Bongaigaon TPS : 750 MW
- Kameng HEP : 600 MW
- Lower Subansiri HEP : 2000 MW

The State has a share of about 316 MW from these future generation schemes. With this, the total share of the State from central sector generating stations shall be about 421 MW. Following lines have been planned to transfer power from these future generation schemes to the state of Tripura:

- Surajmaninagar (Tripura) - Purba Kanchanbari (Tripura) 400kV D/C (to be initially operated at 132kV)

- Purba Kanchanbari (Tripura) – Silchar (POWERGRID) 400kV D/C (to be initially operated at 132kV)

The present intra-state transmission system of the State is quite old & weak and is unable to cater to the growing power requirements of the State. Although the present Transmission & Distribution (T&D) system covers many areas of the State, it is inadequate in its reach and due to non-availability of redundant T&D system, breakdown of any transmission system element results in long term power shortages making the system highly unreliable. Besides, some of the network elements have undergone long term outage due to break-down. Therefore, it has become essential to address the above situation through remedial measures in the transmission and distribution system. Accordingly, phase-wise strengthening of transmission & distribution system has been proposed.

The transmission schemes proposed under this report are priority schemes under Tranche-1 and are essential for improving the power supply situation in the State. Implementation of these schemes will improve quality, reliability, security and enhancement of the power supply in the State.

1.3 PROJECT HIGHLIGHTS

a)	Project Name	:	NER Power System Improvement Project (NERSPIP) – Tranche- I, Tripura
b)	Location	:	Different parts of Tripura State
c)	Beneficiary States	:	Tripura
d)	Project Cost	:	Rs.1372 Cr.
e)	Commissioning Schedule	:	2019

1.4 PROJECT SCOPE & PRESENT STUDY

The present Initial Environment Assessment Report (IEAR) is a document developed to identify possible environmental and social issues related to 132 KV transmission lines and associated 132/33 kV substations in Gumti & South Tripura Districts of Tripura State covered under “NER Power System Improvement Project”. The IEAR provides insight on possible environment & social issues and also describe management measures to minimize/mitigate it based on TSECL’s Environmental and Social Policy & Procedures (ESPP). The scope of IEAR covers the following subprojects;

Sl. No	Transmission Line	Substation
1.	Udaipur - Bagafa 132 kV D/C line (32Km)	Establishment 2 x 50 MVA, 132/33 kV new substation at Bagafa.
2.	Bagafa – Belonia 132 kV D/C line (12.8 Km)	Establishment of 2 x 50 MVA, 132/33 kV new substation at Belonia.
3.	Belonia –Sabroom 132 kV D/C line (46.4 Km)	Establishment of 2x31.5 MVA,132/33 kV new substation at Sabroom.

4.	Bagafa – Satchand 132 kV S/C on D/C line (utilizing the corridor of existing Bagafa – Satchand 66 kV line) (31.2 Km)	Establishment of 2x31.5 MVA, 132/33 kV new substation at Satchand.
5.	Udaipur - Amarpur 132 kV D/C line (16.9 Km)	

The project activities include the survey for finalizing the route alignment and installation of transmission lines and construction of substations (civil and electrical installation). Lattice towers/ poles are then erected on designated places using normal excavation and foundations thereafter conductors are strung across these using manual/stringing machines. The construction of substations is regular civil works for small buildings. The electrical installations consist of the transformers, breakers, capacitors etc. and other protection/controlling devices to ensure required power flow.

A power map showing the transmission grid of Tripura highlighting the above lines and other new projects placed as **Exhibit-1**. Schematic map showing the various subprojects covered under the subject IEAR is placed in **Exhibit -2**.

SECTION – II: BASELINE DATA

2.0 The project is located in the States of Tripura and will pass through the districts of South Tripura & Gumti (part of undivided South Tripura district). The basic environmental settings of the State and subject project area is given below:

2.1 TRIPURA:

Tripura, is situated in the north eastern part of the country and shares international border with Bangladesh from three sides. The area of the State is 10,491 Sq km which forms 0.32% of country's geographical area. The State lies between latitude 22°57' N and 24°33' N and longitude 91°10' and 92°20' E in North Eastern Region physiographic zone. The general land use pattern of the State is given in **Table 2.1**.

Table-2.1 Land use Pattern

Land Use	Area in '000 ha	Percentage
Total geographical area	1,049	
Reporting area for land utilization	1,049	100.00
Forests	629	59.96
Not available for cultivation	141	13.44
Permanent pastures and other grazing lands	02	0.19
Land under misc. tree crops & groves	14	1.33
Culturable wasteland	04	0.38
Fallow lands other than current fallows	02	0.19
Current Fallows	02	0.19
Net area sown	256	24.40

Source: Land use statistics, Ministry of Agriculture, GOI, 2011-12

South Tripura district which also includes the recently created district of Gumti and South Tripura situated approximately between latitude 22°56' and 23°45' N and longitude 91°18' and 91°59' E. The South Tripura district is bounded on the North by Dhalai district and West Tripura district, while on the other sides by international border with Bangladesh. The total geographical area of South Tripura district is 1514.3 Sq.km.

Climate:

The State has a tropical savanna type climate, designated under the Köppen climate classification. The undulating topography leads to local variations, particularly in the hill ranges. The four main seasons are winter from December to February, pre-monsoon or summer from March to April, monsoon from May to September and post-monsoon from October to November. During the monsoon season the south west monsoon brings heavy rains, which cause frequent floods.

The climate of the South Tripura district is mostly warm and is characterized by a humid summer and a dry cool winter.

Rainfall:

The annual rainfall of the State varies between 2,250 mm to 2,500 mm. Average annual rainfall is South Tripura district is about 2000 mm.

Temperature:

The temperature in the State ranges from 21°C to 38°C in summer and 4°C and 33°C in the winter. The temperature of the South Tripura district varies between 8°C to 35°C.

Soils:

The soil in Tripura can be classified into five distinct categories i.e. 1) Red loamy soil and sandy soil (cover 43.07 percent of the total land area of the State). 2) Reddish yellow brown sandy soil (cover 33.06 percent of the land area of the State). The three other types of soil that prevail in the region are the 3) Lateritic soil 4) Younger Alluvial soil 5) Older alluvial soil. The factors influencing the prevalence of different types of soil in Tripura include topographical changes, climate changes, prevalent rock materials and the vegetation. Soil erosion caused by chemical weathering of the soil in the State of Tripura has led to the bed rock of the region being revealed

Water Resources:

The State of Tripura has rich water resources with the presence of as many as ten major rivers, including Gumti, Manu-Deo and Khowai. All rivers are rain-fed and ephemeral in nature. All major rivers originate from hill ranges and show a typical drainage pattern called trellis, except a few instances of dendrite pattern. A study of basin characteristics by CSME (1989) indicate that eight of the ten basins are within the territorial limit of Tripura while basin areas of river Fenni and Langai are shared by two Indian States viz. Tripura and Mizoram and Bangladesh. Collectively basin area of ten major rivers and other minor streams covers nearly 10,500 sq. km. In terms of percentage of the basin of individual rivers vis-a-vis, total basin Gumti (22.66%), is followed by Manu-Deo (18.36%) and Khowai.

The main rivers flowing through South Tripura district are Gumti, Muhuri and Feni. The river Feni forms natural boundary between the South Tripura district and Bangladesh. *However, the project activity is not going to impact these water bodies in any way as the route alignment of proposed transmission lines are quite far from these rivers.*

Ecological Resources:

The recorded forest area of the State is 6,294 sq km which constitutes 59.99% of its geographical area. Reserved forests constitute 66.33%, Protected forests 0.03% and Unclassed forests constitute 33.64%.

Forest Map of the State is enclosed as **Map-1**. The State has six forest types as per Champion & Seth Classification system (1968) which belongs to two forest type groups, viz. Tropical Semi Evergreen and Tropical Moist Deciduous Forests. The proposed transmission lines shall pass through following districts having forest cover of 80.93%. The details of forest resources available in the project area are as follows:

New District	Old District	Geographic area	2013 Assessment (Area in Sq. km)				% Forest cover
			Very Dense forest	Mod Dense forest	Open forest	Total	
Gumti	South Tripura	3057	73	1388	1013	2474	80.93
South Tripura							

Source : Indian State of Forest Report, 2013

Protected Areas:

Tripura has two National Parks and four Wildlife Sanctuaries covering an area of 603.64 sq.km constituting 5.75% of the total geographical area of the State. Details of protected area enclosed as **Annexure-I**. There is no notified elephant reserve/ corridor found in Tripura.

The proposed transmission lines are not passing through any protected area like national parks, sanctuaries, and biosphere reserves etc, as all such areas have been completely avoided through careful route selection. However, some portion of 132 kV D/C Udaipur - Bagafa line alignment is passing at a distance of 1km away from the Trishna Wildlife Sanctuary boundary.

Wetlands:

There are about 408 Wetlands in Tripura covering an area of 98.58 sq.km. Of the total Wetlands, 7 Wetlands are important from the point of view of biodiversity conservation and as centers of socio-economic values and potential sources for eco-tourism in the State. The Rudrasagar lake of State is also covered under International Convention (Ramsar Convention on wet land) by MoEF. **However, none of these wetlands are getting involved/impacted in routing/RoW of proposed lines and locating substations.**

Minerals:

Oil and natural gas are the most important mineral resources in Tripura. ONGC or oil and natural gas corporation has initiated massive exploration programme in the State. Other minerals of significance are glass sand, plastic clay, shale etc.

Human and Economic Development:

The population of Tripura as per census 2011 was 36,71,032. The Scheduled Tribes (STs) population consists nearly 31.13% of the total population in the State. There are 19 sub tribes among the ST population of the State with their own cultural identity. This project is being implemented in the tribal areas, governed by Tripura Tribal Autonomous District Council (TTADC) as per the provisions Sixth Schedule of the Indian Constitution. Since TTADC areas accounts for 70% of the total geographical area of the state and over 80% of the tribal population of the state the project benefit will largely accrue to tribal population

Tripura is an agrarian State with more than half of the population dependent on agriculture and allied activities. However, due to hilly terrain and forest cover, only 27 per cent of the land is available for cultivation. Rice, the major crop of the state, is

cultivated in 91 per cent of the cropped area. According to the Directorate of Economics & Statistics, Government of Tripura, in 2009–10 potato, sugarcane, pulses and jute were the other major crops cultivated in the State. Jackfruit and pineapple top the list of horticultural products. Traditionally, most of the indigenous population practiced jhum method (a type of slash-and-burn) of cultivation. The number of people dependent on jhum has declined over the years.

Pisciculture has made significant advances in the State. At the end of 2009–10, the State produced a surplus of 104.3 million fish seeds. Rubber and tea are the important cash crops of the State. Tripura ranks second only to Kerala in the production of natural rubber in the country. The State is known for its handicraft, particularly hand-woven cotton fabric, wood carvings, and bamboo products. High quality timber including sal, garjan, teak and gamar are found abundantly in the forests of Tripura. The industrial sector of the State continues to be highly underdeveloped – brickfields and tea industry are the only two organised sectors. Tripura has considerable reservoirs of natural gas. According to estimates by Oil and Natural Gas Corporation (ONGC), the State has 400 billion cu.m reserves of natural gas, with 16 billion cu.m is recoverable. ONGC produced 480 million cu.m natural gas in the State, in 2006–07. In 2011 and 2013, new large discoveries of natural gas were announced by ONGC.

The economy of Tripura can be characterized by rate of poverty, low capital formation in-adequate infrastructure facilities, Geographical isolation and communication bottleneck, in-adequate exploration and use of forest and mineral resources, slow industrialization and high unemployment. More than 50% of the population depends on agriculture for sustaining their livelihood. However, share of agriculture and allied activities in Gross State Domestic Production (GSDP) is only 23% primarily due to low capital base in the sector.

South Tripura District has total Geographic Area of 1514.3 sq km. As per 2011 census, the population of the district is 4,53,079 with a population density of 299 per sq km. **Around 91.5% population of the district resides in rural areas.** The district enjoys a high literacy rate of 85.09%. The sex ration of the district is 935 females per 1000 males, which is better than the corresponding National figure. Around 72% rural population of the district is below the poverty line, which indicates weak economic base and under-development.

Agriculture is the main profession/source of livelihood of the district, **with a net sown area of around 41,840 Ha.** Paddy is the main food crop. Potato, sugarcane, jute and mustard are also grown. Fisheries and Animal Husbandry are other prominent sources of employment; current fish productivity of the district is 2281 kg/Ha/year.

The district has not witnessed much industrial growth due to varied reasons, with presence of only two Industrial Areas located at Belonia and at Sabroom. There are about 132 nos. of reported registered factories in the district employing around 2250 workers. There are 5 nos. of Handloom units and around 18750 nos. of handloom weavers in the district. It has been informed that lack of reliable and uninterrupted power is considered to be major hurdle in the industrial development of the area.

Additional/detailed information regarding the environmental and social features along the alignment is provided in Section- IV

SECTION III: POLICY, LEGAL & REGULATORY FRAMEWORK

3.0 Power transmission project activities by their inherent nature and flexibility have negligible impacts on environmental and social attributes. Indian laws relating to environmental and social issues have strengthened in the last decade both due to local needs and international commitments. TSECL undertakes its activities within the purview of Indian and State specific laws keeping in mind appropriate international obligations and directives and guidelines with respect to environmental and social considerations of Funding Agencies.

3.1 ENVIRONMENTAL

3.1.1 CONSTITUTIONAL PROVISIONS

Subsequent to the first United Nations Conference on Human Environment at Stockholm in June, 1972, which emphasized the need to preserve and protect the natural environment, the Constitution of India was amended through the historical 42nd Amendment Act, 1976 by inserting Article 48-A and 51-A(g) for protection and promotion of the environment under the Directive Principles of State Policy and the Fundamental Duties respectively. The amendment, *inter alia* provide:

"The State shall endeavour to protect and improve the environment and to safeguard the forests and wildlife of the country". (New Article 48A)

"It shall be the duty of every citizen of India to protect and improve the natural environment including forests, lakes, rivers and wildlife and to have compassion for living creatures". (New Article 51 A (g))

Article 21 of the constitution provides, "no person shall be deprived of his life or personal liberty except according to procedure established by law".

Article 21 is the heart of the fundamental rights and has received expanded meaning from time to time after the decision of the Supreme Court in 1978. The Article 21 guarantee fundamental right to life – a life of dignity to be lived in a proper environment, free of danger of disease and infection. The right to live in a healthy environment is part of Article 21 of the Constitution. Recently, Supreme Court has broadly and liberally interpreted the Article 21, transgressed into the area of protection of environment, and held that the protection of environment and citizen's right to live in eco-friendly atmosphere interpreted as the basic right guaranteed under Article 21.

Thus the Indian Constitution has now two fold provision:

- (a) On the one hand, it gives directive to the State for the protection and improvement of environment.
- (b) On the other hand the citizens owe a constitutional duty to protect and improve natural environment.

Sixth Schedule

In Tripura, special provisions have been extended to the Tribal Areas under the 6th Schedule [Articles 244(2) and 275(1)] in addition to basic fundamental rights. Besides, the Tripura Panchayats (Second Amendment) Act, 1998 of Principal Act, 1993 includes ADC in Government functioning. The Sixth Schedule is entirely focused at protection of tribal areas and interests by allowing self-governance through constitutional institutions at the district or regional level. These institutions are entrusted with the twin task of protecting tribal cultures and customs and undertaking development tasks.

The Sixth Schedule of the Constitution applies to a large part of the state, which is under the jurisdiction of the “Tripura Tribal Areas Autonomous District Council” (TTAADC). Out of the total geographical area of 10,491 sq. km, 7,133 sq. km (about 68%) is under the TTAADC. The Sixth Schedule areas are governed through “Autonomous District Councils” (ADC) that has wide-ranging legislative and executive powers. The purpose of establishing the Autonomous District Council (ADC) is to provide for internal autonomy to the tribal people inhabiting these areas, and protect their social, cultural and economic interests, through granting them administrative and legal authority as per constitution of India.

3.1.2 MANDATORY REQUIREMENTS (NATIONAL)

- **GoT order/sanction under The Electricity Act, 2003:**

Sanction of GoT is a mandatory requirement for taking up any new transmission project under the section 68(1) of The Electricity Act, 2003. The sanction authorize TSECL to plan and coordinate activities to commission the new project. Electricity Act does not explicitly deal with environmental implications of activities related to power transmission and construction of substation. However, TSECL integrates environmental protection within its project activities.

- **Forest Clearance under the Forest (Conservation) Act, 1980:**

When transmission projects pass through forest land, clearance has to be obtained from relevant authorities under the Forest (Conservation) Act, 1980. This Act was enacted to prevent rapid deforestation and environmental degradation. State governments cannot de-reserve any forest land or authorize its use for any non-forest purposes without approval from the Central government. TSECL projects, when involving forest areas, undergo detailed review and approval procedures to obtain a Forest Clearance certificate from MoEF, Government of India before starting any construction activity in designated forest area.

- **Environmental Clearances under Environment (Protection) Act, 1986:**

Since transmission line projects are environmentally clean and do not involve any disposal of solid waste, effluents and hazardous substances in land, air and water they are kept out of the purview of Environment (Protection) Act, 1986. However, amendment in the Environment (Protection) Act, 1986 on 7th May' 1992 made it necessary to obtain clearance from MoEF for power transmission projects in two districts in the Aravalis (*viz.*, Alwar in Rajasthan and Gurgaon in Haryana). The Aravali

range, in these two areas, is heavily degraded, hence, any industrial activity there becomes critical. Environment Impact Notification, 1994 & 2006 lays down specific project categories that require clearance from MoEF Power transmission projects are not included in this list.

- **Ozone Depleting Substances (Regulation and Control) Rules, 2000 :**

MoEF vide its notification dtd. 17th July, 2000 under the section of 6, 8 and 25 of the Environment (Protection) Act, 1986 has notified rules for regulation /control of Ozone Depleting Substances under Montreal Protocol adopted on 16th September 1987. As per the notification certain control and regulation has been imposed on manufacturing, import, export and use of these compound. TSECL shall follow provisions of notification and phase out all equipments which uses these substances and planning to achieve CFC free organization in near future.

- **Batteries (Management and Handling) Rules, 2001:**

MoEF vide its notification dtd. 16th May, 2001 under the section of 6, 8 and 25 of the Environment (Protection) Act, 1986 has put certain restriction on disposal of used batteries and its handling. As per the notification it is the responsibility of bulk consumer (TSECL) to ensure that used batteries are not disposed of, in any manner, other than by depositing with the dealer/manufacturer/registered recycler/importer/reconditioner or at the designated collection centres and to file half yearly return in prescribed form to the concerned State Pollution Control Board.

- **Hazardous Wastes (Management, Handling and Transboundary Movement) Rules, 2008 :**

Vide notification dated 24th September, 2008 under the EPA, 1986, MoEF notified rules for environmentally sound management of hazardous wastes to ensure that the hazardous wastes are managed in a manner which shall protect health and the environment against the adverse affects that may result from such waste. The used transformer oil has been declared as hazardous wastes vide this notification.

TSECL, being a bulk user of transformer oil shall comply with the provisions of the said rules (MoEF notification dated 24th September 2008) if the practice of storing of used oil is maintained. In case it is decided to outsource the process of recycle of used oil to registered recycler as per the provisions of notification then TSECL shall submit the desired return in prescribed form to concerned State Pollution Control Board at the time of disposal of used oil.

- **E-waste (Management and Handling) Rules, 2011:**

Vide notification dated 12th May 2011 under the EPA, 1986, MoEF notified rules for environmentally sound management of e-waste to ensure that e-waste are managed in a manner which shall protect health and the environment against the adverse affects that may result from hazardous substance contained in such wastes. Thus, it is the

responsibility of the bulk consumer (TSECL) to ensure that e-waste generated is channelized to authorized collection center(s) or registered dismantler(s) or recycler(s) or is return to the pick-up of take back services provided by the producer. TSECL, being a bulk consumer of electrical and electronics equipments shall maintain the record as per Form-2 for scrutiny by State Pollution Control Board.

- **The Biological Diversity Act, 2002 :**

Under the United Nations Convention on Biological Diversity signed at Rio de Janeiro on the 5th June, 1992 of which India is also a party, Gol has enacted the Biological Diversity Act, 2002 to provide for conservation of biological diversity, sustainable use of its components and fair and equitable sharing of the benefits arising out of the use of biological resources, knowledge and for matters connected therewith. As per the provision of act certain area which are rich in biodiversity and encompasses unique and representative ecosystems are identified and designated as Biosphere Reserve to facilitate its conservation. All restrictions applicable to protected areas like National Park & Sanctuaries are also applicable to these reserves TSECL will abide by the provision of act wherever applicable, and will try to totally avoid these biosphere reserves while finalizing the route alignment.

- **The Scheduled Tribes & Other Traditional Forest Dwellers (Recognition of Forest Rights) Act, 2006**

This act recognizes and vests the forest rights and occupation in forest land to forest dwelling. Scheduled Tribes and other traditional forest dwellers who have been residing in such forests for generations but whose rights could not be recognized.

The definitions of forest dwelling schedule tribes, forestland, forest rights, forest villages, etc. have been included in Section 2 of the Act. The Union Ministry of Tribal Affairs (MoTA) is the nodal agency for implementation of the Act while field implementation is the responsibility of the respective State government agencies. Its implementation has also been linked with forest clearance process under Forest (Conservation) Act, 1980 w.e.f. August 2009 by MoEF. TSECL shall abide by the provisions of the act if any portion of the transmission line is passing through forest land, in occupation of the forest dwelling scheduled tribes and other traditional forest dwellers for laying of transmission lines. However, for linear projects including transmission lines obtaining of NoC from the gram sabha has been exempted for the requirement of FRA compliance as per MoEF circular dated 5th February 2013 and 15th January 2014.

3.1.3 FUNDING AGENCY:

For TSECL, mandatory environment requirements with respect to WB Operational Policies are as follows:

- **World Bank (WB) Operational Policies (OP) 4.01: Environmental Assessment**

The policy objective is to ensure the environmental and social soundness and sustainability of investment projects and support integration of environmental and social aspects of projects in the decision-making process.

TSECL takes remedial measures to prevent, minimize, mitigate, or compensate for adverse impact and improve environmental performance. Environment Assessment will take into account the natural environment, human health and safety, and social aspects and trans-boundary and global environmental aspects. During EA process public is also informed at every stage of project execution and their views are considered during decision-making process.

- **World Bank OP 4.04: Natural Habitats**

The policy objective is to promote sustainable development by supporting the protection, conservation, maintenance, and rehabilitation of natural habitats and their functions.

- **World Bank OP 4.11: Physical Cultural Resources**

The policy objective is to preserve PCR and in avoiding their destruction or damage. PCR includes resources of archeological, paleontological, historical, architectural, and religious (including graveyards and burial sites), aesthetic, or other cultural significance.

- **World Bank OP 4.36: Forests**

The objective of this policy is to realize the potential of forests to reduce poverty in a sustainable manner, integrate forests effectively into sustainable economic development, and protect the vital local and global environmental services and values of forests.

3.2. SOCIAL

3.2.1 CONSTITUTIONAL PROVISIONS

Constitutional provisions in regard to social safeguards are well enshrined in the preamble such as **JUSTICE**, social, economic and political; **LIBERTY** of thought, expression, belief, faith and worship; **EQUALITY** of status and of opportunity; **FRATERNITY** assuring the dignity of the individual and the unity and integrity of the Nation. Fundamental Rights and Directive Principles guarantee the right to life and liberty. Health, safety and livelihood have been interpreted as part of this larger right. Social safeguards provisions are dealt in detail in different Article such as Article-14, 15, 17, 23, 24, 25, 46, 330, 332 etc. TSECL shall implement the said constitutional provision in true spirit to fulfill its environmental and social obligations and responsibilities.

3.2.2 MANDATORY REQUIREMENTS (NATIONAL)

- **The Right to Fair Compensation and Transparency in Land Acquisition, Rehabilitation and Resettlement Act, 2013 (RFCTLARRA) :**

Govt. of India replaced the old Land Acquisition Act, 1894 and notified the new RFCTLARRA, 2013 which came into force from 1st January 2014. This act ensures appropriate identification of the affected families/households, fair compensation and rehabilitation of titleholders and non-titleholders. However, the new act i.e. RFCTLARRA, 2013 authorizes State Govt. (i.e. GoT) or its authorized Government agency to complete the whole process of acquisition of private land including Social Impact Assessment (SIA), Action Plan for R&R (i.e. Rehabilitation and Resettlement) &

its implementation and the TSECL responsibility is limited to identification and selection of suitable land based on technical requirement and ensuring budget allocation.

- **Rights of Way and Compensation under Electricity Act, 2003 :**

The Electricity Act, 2003 has a provision for notifying transmission company under section 164 (B) to avail benefits of eminent domain provided under the Indian Telegraph Act, 1885. Under this section TSECL may seek for GoT authorization to exercise all the powers that the Telegraph authority possesses and can spot, construct and erect towers without acquiring the land. Moreover, all damages due to its activity shall be compensated at market rate. In case of agricultural or private land the provisions of section- 67 and/or section-68 (5 & 6) of the Electricity Act, 2003 and section-10 of the Indian Telegraph Act, 1885 are followed for assessment and payment of compensation towards such damages

3.2.3 FUNDING AGENCY

For TSECL, mandatory social requirements with respect to WB Operational Policies are as follows:

- **World Bank OP 4.12: Involuntary Resettlement**

This policy covers direct economic and social impacts both resulting from Bank-assisted investment projects, and are caused by the involuntary taking of land. To avoid or minimize involuntary resettlement and, where this is not feasible, assist displaced persons in improving or at least restoring their livelihoods and standards of living in real terms relative to pre-displacement levels or to levels prevailing prior to the beginning of project implementation, whichever is higher.

- **World Bank OP 4.10: Indigenous People (IP)**

This policy contributes to the Bank's mission of poverty reduction and sustainable development by ensuring that the development process fully respects the dignity, human rights, economies, and cultures of Indigenous Peoples. The objective is to design and implement projects in a way that fosters full respect for indigenous peoples" so that they receive culturally compatible social and economic benefits, and do not suffer adverse effects during the development process. The project shall ascertain broad community support for the project based on social assessment and free prior and informed consultation with the affected Tribal community, if any.

SECTION IV :

APPROACH FOR ROUTE/SITE SELECTION

4.0 ROUTE SELECTION - (ASSESSMENT & MANAGEMENT PROCESS)

At the system planning stage itself one of the factors that govern the evolution of system is the possible infringement with the forest. Wherever such infringements are substantial, different alternative options are considered. The route/ site selection criteria followed is detailed below:

While identifying the transmission system, preliminary route selection is done by TSECL based on the Survey of India Topo sheets, Forest Atlas (Govt. of India's Publication) and Google Maps etc. During route alignment all possible efforts are made to avoid the forest area involvement completely or to keep it to the barest minimum, whenever it becomes unavoidable due to the geography of terrain or heavy cost involved in avoiding it. *Presence of important/protected natural habitats (IUCN category I - IV) is verified by superimposing the proposed alternative alignment on the Integrated Biodiversity Assessment Tool (IBAT) map. IBAT is a very informative decision-making tool to address possible infringement with potential biodiversity important areas and has been developed through a partnership of global conservation leaders including Bird Life International, Conservation International (CI), the United Nations Environment Programme World Conservation Monitoring Centre (UNEP-WCMC) and the International Union for Conservation of Nature (IUCN) for conservation/protection of such areas.*

4.1.1 STUDY OF ALTERNATIVES

Environmental Criteria for Route selection

For selection of optimum route, the following points are taken into consideration:

- (i) The route of the proposed transmission lines does not involve any human rehabilitation
- (ii) Any monument of cultural or historical importance is not affected by the route of the transmission line.
- (iii) The proposed route of transmission line does not create any threat to the survival of any community with special reference to Tribal Community.
- (iv) The proposed route of transmission line does not affect any public utility services like playgrounds, schools, other establishments etc.
- (v) The line route does not pass through any National Parks, Sanctuaries etc.
- (vi) The line route does not infringe with area of natural resources.

In order to achieve this, TSECL undertakes route selection for individual transmission lines in close consultation with representatives of concerned Forest Department and the Department of Revenue. Although under the law, TSECL has right of eminent domain yet alternative alignments are considered keeping in mind the above-mentioned factors

during site selection, *with minor alterations often added to avoid environmentally sensitive areas and settlements at execution stage.*

- As a rule, alignments are generally cited away from major towns, whenever possible, to account for future urban expansion.
- Similarly, forests are avoided to the extent possible, and when it is not possible, a route is selected in consultation with the local Divisional Forest Officer, that causes minimum damage to existing forest resources.
- Alignments are selected to avoid wetlands and unstable areas for both financial and environmental reasons.

In addition, care is also taken to avoid National parks, Sanctuaries, Eco-sensitive zones, Tiger reserves, Biosphere reserves, Elephant corridors and IBA sites etc. Keeping above in mind the routes of proposed lines under the project have been so aligned that it takes care of above factors. As such different alternatives for transmission lines were studied with the help of Govt. published data like Forest atlas, Survey of India etc. and Google Maps to arrive at most optimum route which can be taken up for detailed survey and assessment of environmental & social impacts for their proper management.

A. TRANSMISSION LINE

1. EVALUATION OF ALTERNATIVES ROUTE ALIGNMENT FOR 132 KV D/C UDAIPUR –BAGAFa TRANSMISSION LINE

Three (3) different alignments (**Map-2** in KML format attached) were studied with the help Google Maps and walkover survey to arrive at most optimum route for detailed survey. This was then verified on web-based IBAT Database and an image for the same is provided in **Map - 3**. The comparative details of these three alternatives in respect of the proposed line are as follows:

S.N	Description	Alternative-I	Alternative-II	Alternative-III
1.	Route particulars (Bee Line Length - 24.5 km)			
i.	Route Length (km)	32	27	34.8
ii.	Terrain			
	Hilly (Gentle slope)	40%	70%	80%
	Plain	60%	30%	20%
2.	Environmental impact			
i.	Name of District through which the line passes	Gumti & South Tripura	Gumti & South Tripura	Gumti & South Tripura.
ii.	Towns in alignment	Udaipur, Bagafa & Santirbazaar.	Udaipur, Bagafa & Santirbazaar	Udaipur, Bagafa & Santirbazaar
iii.	House within RoW	Shall be ascertained after detailed survey	Shall be ascertained after detailed survey	Shall be ascertained after detailed survey
iv.	Forest involvement in Ha/km	59.4 ha/ 22 km	70.2ha / 26 km	81ha /30 km

S.N	Description	Alternative-I	Alternative-II	Alternative-III
v.	Type of Forest (RF/PF/Mangrove/ Wildlife Area/ Elephant corridor/ Biodiversity Hotspots/Biosphere Reserve/Wetlands or any other environmentally sensitive area.	Reserved Forest & Trishna wildlife sanctuary is approx. 1 km from the line	Reserved Forest & Trishna wildlife sanctuary is coming across the route.	Reserved Forest & Trishna wildlife sanctuary is approx.5 km from the line
vi.	Density of Forests	Low	Moderate	Dense
vii.	Type of flora	Mainly Sal, Teak, Rubber etc.	Mainly Sal, Teak, Rubber etc.	Mainly Sal, Teak, Rubber etc.
viii.	Type of fauna	Crow, Sparrow, Pigeon, Lizard, Fox, Monkey, Cat, Snake etc.	Crow, Sparrow, Pigeon, Lizard, Fox, Monkey, Cat, Snake etc.	Crow, Sparrow, Pigeon, Lizard, Fox, Monkey, Cat, Snake etc.
ix.	Endangered species, if any	Nil	Nil	Nil
x.	Historical/cultural monuments	Nil	Nil	Nil
3.	Compensation Cost			
i.	Crop (Non Forest)	Rs 50.00 lakhs (Approx.)	Rs. 5.00 lakhs (Approx.)	Rs. 24.00 lakhs (Approx.)
ii.	Forest (CA, NPV etc.)	Rs. 11.88 Crores (Approx.)	Rs. 14.04 Crores (Approx.)	Rs. 16.20 Crores (Approx.)
4.	Major Crossings			
i.	Highway (National/State)	1 (NH)	1 (NH)	1 (NH)
ii.	Power line	Nil	Nil	Nil
iii.	Railway line	1	1	1
iv.	River crossing	Nil	Nil	Nil
5.	Construction problems	Less due to involvement of more plain area and better approaches	Moderate	High
6.	O&M problems	O&M shall be easier due to less hilly & forest area and better approaches	Moderate	High

From the comparative analysis it is evident that complete avoidance of reserved forest area is not possible as reserved forest invariably intercepts with all the three alternatives studied around the bee line. However, Alternative Route-I is shorter in length as compared to Alternative-II and Alternative-III and pass through mostly plain area with minimum stretch of reserved forest area and avoiding the Trishna Wildlife Sanctuary which is approx. 1 km away from line. Therefore, Alternative-I found to be the most optimum and recommended for detailed survey.

2. EVALUATION OF ALTERNATIVES ROUTE ALIGNMENT FOR 132 KV D/C UDAIPUR – AMARPUR TRANSMISSION LINE

Three (3) different alignments (**Map- 4** in KML format attached) were studied with the help of Google Maps and walkover survey to arrive at most optimum route for detailed survey. The comparative details of these three alternatives in respect of the proposed line are as below:

S.N	Description	Alternative-I	Alternative-II	Alternative-III
1.	Route particulars (Bee Line Length - 15 km)			
i	Route Length (km)	16.9	19	18.6
ii.	Terrain			
	Hilly (Gentle slope)	80%	80%	80%
	Plain	20%	20%	20%
2.	Environmental impact			
i	Name of District through which the line passes	Gumti	Gumti	Gumti
ii	Towns in alignment	Udaipur & Amarpur	Udaipur & Amarpur	Udaipur & Amarpur
iii	House within RoW	Shall be ascertained after detailed survey	Shall be ascertained after detailed survey	Shall be ascertained after detailed survey
iv	Forest involvement in Ha/km	21.33Ha./ 7.9 km	24.3 Ha./ 9 km	32.4 Ha./12 km
v	Type of Forest (RF/PF/Mangrove/ Wildlife Area/ Elephant corridor/ Biodiversity Hotspots/Biosphere Reserve/Wetlands or any other environmentally sensitive area.	Reserved Forest (Deotamura Barmura RF)	Reserved Forest (Deotamura Barmura RF)	Reserved Forest (Deotamura Barmura RF)
vi	Density of Forests	Moderate	Moderate	Dense
vii	Type of flora	Mainly Sal, Teak and Rubber etc.	Mainly Sal, Teak and Rubber etc.	Mainly Sal, Teak and Rubber etc.
viii	Type of fauna	Crow, Sparrow, Fox, Pigeon, Lizard, Cat, Monkey, Snake etc.	Crow, Sparrow, Fox, Pigeon, Lizard, Cat, Monkey, Snake etc.	Crow, Sparrow, Fox, Pigeon, Lizard, Cat, Monkey, Snake etc.
ix	Endangered species, if any	Nil	Nil	Nil
x	Historical/cultural monuments	Nil	Nil	Nil
3	Compensation Cost			
i	Crop (Non Forest)	Rs 45.00 lakhs (Approx.)	Rs 50.00 lakhs (Approx.)	Rs 33.00 lakhs (Approx.)
ii	Forest (CA, NPV etc.)	Rs 4.26 Crore (Approx)	Rs 4.86 Crore (Approx)	Rs 6.48 Crore (Approx)

S.N	Description	Alternative-I	Alternative-II	Alternative-III
4.	Major Crossings			
i	Highway (National/State)	1 (SH)	1 (SH)	1 (SH)
ii	Power line	Nil	Nil	Nil
iii	Railway line	Nil	Nil	Nil
iv	River crossing	Nil	Nil	Nil
5.	Construction problems	Less due to easy approaches and less involvement of forest area	Comparatively more due to difficult approaches and involvement of more forest area	Most difficult due to non existing approach path and involvement of more forest area
6.	O&M problems	O&M shall be easier due to less forest involvement and better approaches	Moderate	High

From the above comparative analysis, Alternative-I is shortest in length than Alternative-II and Alternative-III. It is also observed that complete avoidance of reserved forest is not possible in any of the route alignments studied around bee line. However, it is evident that Alternative-I involve minimum stretch of reserved forest and also tree felling will be minimum. Therefore, Alternative-I is found more optimum and recommended for detailed survey.

3. EVALUATION OF ALTERNATIVES ROUTE ALIGNMENT FOR 132 KV D/C BAGAF A – SATCHAND TRANSMISSION LINE

Three (3) different alignments (**Map- 5** in KML format attached) were studied with the help Google Maps and walkover survey to arrive at most optimum route for detailed survey. The comparative details of these three alternatives in respect of the proposed transmission line are as below:

S.N	Description	Alternative-I	Alternative-II	Alternative-III
1.	Route particulars (Bee Line Length -26.2 km)			
i	Route Length (km)	31.2	29.4	40.3
ii.	Terrain			
	Hilly (Gentle slope)	40%	70%	80%
	Plain	60%	30%	20%
2.	Environmental impact			
i	Name of District through which the line passes	South Tripura	South Tripura	South Tripura
ii	Towns in alignment	Bagafa, Satchand, Santirbazaar & Sabroom	Bagafa, Satchand , Santirbazaar & Sabroom	Bagafa, Satchand , Santirbazaar & Sabroom
iii	House within ROW	Shall be ascertained after detailed survey	Shall be ascertained after detailed survey	Shall be ascertained after detailed survey
iv	Forest involvement in Ha./km	13.5 Ha./5 km	43.2 Ha/ 16 km	48.6 Ha./18 km

S.N	Description	Alternative-I	Alternative-II	Alternative-III
v	Type of Forest (RF/PF/Mangrove/ Wildlife Area/ Elephant corridor/Biodiversity Hotspots/Biosphere Reserve/Wetlands or any other environmentally sensitive area.	Reserved Forest (Proposed)	Reserved Forest (Tekka Tulsi RF)	Reserved Forest (Muhuripur and Deotamura Barmura RF)
vi	Density of Forests	Moderate	Dense	Dense
vii	Type of flora	Mainly Sal, Teak and Rubber etc.	Mainly Sal, Teak and Rubber etc.	Mainly Sal, Teak and Rubber etc.
viii	Type of fauna	Crow, Sparrow, Pigeon, Lizard, Fox, Monkey, Cat, Snake etc.	Crow, Sparrow, Pigeon, Lizard, Fox, Monkey, Cat, Snake etc.	Crow, Sparrow, Pigeon, Lizard, Fox, Monkey, Cat, Snake etc.
ix	Endangered species, if any	Nil	Nil	Nil
x	Historical/cultural monuments	Nil	Nil	Nil
3	Compensation Cost			
i	Crop (Non Forest)	Rs. 1.31 Crore (Approx.)	Rs. 67. 00 Lakh (Approx.)	Rs. 1.11 Crore (Approx.)
ii	Forest (CA, NPV etc)	Rs. 2.70 Crore (Approx.)	Rs. 8.64 Crore (Approx.)	Rs. 9.72 Crore (Approx.)
4.	Major Crossings			
i	Highway (National/State)	1 (NH)	1 (NH)	2 (NH)
ii	Power line	Nil	Nil	Nil
iii	Railway line	1	1	Nil
iv	River crossing	Nil	Nil	Nil
5.	Construction problems	Less due to involvement of more plain area and better approaches	Comparatively more due to involvement more hilly and forest area	Most difficult due to involvement more hilly and forest area
6.	O&M problems	O&M shall be easier due to less hilly & forest area and better approaches	Moderate	High

From the above comparison of the three different alternatives, it is observed that complete avoidance of reserved forest is not possible in any of the route alignments studied around bee line. Although Alternative-I is not the shortest route length and little higher in length than Alternate –II but it involves minimum stretch of reserved forest and also tree felling will be minimum. Alternative-I is least affecting the environment as compared to other alternatives. Therefore, Alternative-I is found to be most optimum alignment and recommended for detailed survey

4. EVALUATION OF ALTERNATIVES ROUTE ALIGNMENT FOR 132 KV D/C BAGAF A –BELONIA TRANSMISSION LINE

Three (3) different alignments (**Map- 6** in KML format attached) were studied with the help of published data Google Maps and walkover survey to arrive at most optimum route for detailed survey. The comparative details of these three alternatives in respect of the proposed transmission Line are as follows:

S.N	Description	Alternative-I	Alternative-II	Alternative-III
1.	Route particulars (Bee Line Length – 10.6 km)			
i	Route Length (km)	12.8	13.5	12.2
ii.	Terrain			
	Hilly (Gentle slope)	40%	40%	40%
	Plain	60%	60%	60%
2.	Environmental Impact			
i	Name of District through which the line passes	South Tripura	South Tripura	South Tripura
ii	Town in alignment	Bagafa, Belonia. & Santirbazaar	Bagafa, Belonia. & Santirbazaar	Bagafa, Belonia. & Santirbazaar
iii	House within ROW	Shall be ascertained after detailed survey	Shall be ascertained after detailed survey	Shall be ascertained after detailed survey
iv	Forest involvement in Ha/km	16.55 Ha./6.13 km	24.3 Ha. / 9 km	20.25 Ha./7.5 km
v	Type of Forest (RF/PF/Mangrove/Wildlife Area/Elephant corridor/Biodiversity Hotspots/Biosphere Reserve/Wetlands or any other environmentally sensitive area.	Reserved Forest (proposed)	Reserved Forest (proposed)	Reserved Forest (proposed) and some portion of Bormura Deoutanmura RF
vi	Density of Forests	Low	Moderate	High
vii	Type of flora	Mainly Sal, Teak and Rubber etc.	Mainly Sal, Teak and Rubber etc.	Mainly Sal, Teak and Rubber etc.
viii	Type of fauna	Crow, Sparrow, Pigeon, Lizard, Fox, Monkey, Cat, Snake etc.	Crow, Sparrow, Pigeon, Lizard, Fox, Monkey, Cat, Snake etc.	Crow, Sparrow, Pigeon, Lizard, Fox, Monkey, Cat, Snake etc.
ix	Endangered species, if any	Nil	Nil	Nil
x	Historical/cultural monuments	Nil	Nil	Nil
3	Compensation Cost			
i	Crop (Non Forest)	Rs. 33.35 Lakh (Approx.)	Rs. 22.50 Lakh (Approx.)	Rs. 23.50 Lakh (Approx.)
ii	Forest (CA, NPV etc.)	Rs. 3.31 Crore (Approx)	Rs. 4.86 Crore (Approx)	Rs. 4.05 Crore (Approx)

S.N	Description	Alternative-I	Alternative-II	Alternative-III
4.	Major Crossings			
i	Highway (National/State)	1 (SH)	1 (SH)	1 (SH)
ii	Power line	Nil	Nil	Nil
iii	Railway line	1	1	1
iv	River crossing	Nil	Nil	Nil
5.	Construction problems	Less due to easy approaches and less involvement of forest area	Most difficult due less approachability and involvement of more forest area	Comparatively more due difficult approaches and involvement of more forest area
6.	O&M problems	O&M shall be easier due to less forest involvement and better approaches	High	Moderate

From the above comparison of the three different alternatives, it is observed that complete avoidance of reserved forest is not possible in any of the route alignments studied around bee line. Although Alternative-I is not the shortest in route length and little higher in length than Alternate –III but it involves minimum stretch of reserved forest and also tree felling will be minimum. Alternative-I is least affecting the environment as compared to other alternatives. Therefore, Alternative-I is found to be most optimum alignment and recommended for detailed survey

5. EVALUATION OF ALTERNATIVES ROUTE ALIGNMENT FOR 132 KV D/C BELONIA -SABROOM T/L

Three (3) different alignments (**Map-7** in KML format attached) were studied with the help of published data Google Maps and walkover survey to arrive at most optimum route for detailed survey. The comparative details of these three alternatives in respect of the proposed transmission Line are as follows:

S.N	Description	Alternative-I	Alternative-II	Alternative-III
1.	Route particulars (Bee Line Length – 34 KM)			
i	Route Length (km)	46.4	35	38
ii.	Terrain			
	Hilly (Gentle slope)	20%	80%	90%
	Plain	80%	20%	10%
2.	Environmental Impact			
i	Name of District through which the line passes	South Tripura	South Tripura	South Tripura
ii	Town in alignment	Belonia & Sabroom.	Belonia & Sabroom	Belonia & Sabroom
iii	House within ROW	Shall be ascertained after detailed survey	Shall be ascertained after detailed survey	Shall be ascertained after detailed survey

S.N	Description	Alternative-I	Alternative-II	Alternative-III
iv	Forest involvement in Ha/km	35.1 Ha./13 km.	54 Ha./ 20 km	83.7 Ha./31 km
v	Type of Forest (RF/PF/Mangrove/ Wildlife Area/ Elephant corridor/ Biodiversity Hotspots/Biosphere Reserve/Wetlands or any other environmentally sensitive area.	Reserved Forest (Tekka Tulsı R.F)	Reserved Forest (Tekka Tulsı R.F)	Reserved Forest (Tekka Tulsı R.F)
vi	Density of Forests	Moderate	High	High
vii	Type of flora	Mainly Sal, Teak and Rubber etc.	Mainly Sal, Teak and Rubber etc.	Mainly Sal, Teak and Rubber etc.
viii	Type of fauna	Crow, Sparrow, Pigeon, Lizard, Fox, Monkey, Cat, Snake etc.	Crow, Sparrow, Pigeon, Lizard, Fox, Monkey, Cat, Snake etc.	Crow, Sparrow, Pigeon, Lizard, Fox, Monkey, Cat, Snake etc.
ix	Endangered species, if any	Nil	Nil	Nil
x	Historical/cultural monuments	Nil	Nil	Nil
3	Compensation Cost			
i	Crop (Non Forest)	Rs. 1.67 Crore (Approx.)	Rs. 0.75 Crore (Approx.)	Rs. 0.35 Crore (Approx.)
ii	Forest (CA, NPV etc.)	Rs. 6.30 Crore (Approx)	Rs10.80 Crore (Approx)	Rs. 16.74 Crore (Approx)
4.	Major Crossings			
i	Highway (National/State)	Nil	Nil	Nil
ii	Power line	Nil	Nil	Nil
iii	Railway line	1	1	1
iv	River crossing	Nil	Nil	Nil
5.	Construction problems	Less due to easy approachability through plain area and less involvement of forest	Comparatively more due to involvement more hilly and forest area	Most difficult due to involvement more hilly and forest area
6.	O&M problems	O&M shall be easier due to less hilly & forest area and better approaches	Moderate	High

From the above comparison of the three different alternatives, it is observed that complete avoidance of reserved forest is not possible in any of the route alignments studied around bee line. Although Alternative-I route alignment is longer than Alternative – II & III, but involves minimum forest area and easily approachable due to plane terrain. Alternative-II & III are comparatively having high involvement of forest area and more

number of tree felling. Hence Alternative-I which is least affecting the environment is found to be most optimum alignment and recommended for detailed survey.

B. SUBSTATION:

For substation site selection also analysis of 2-3 alternatives sites is carried out based on environment and social aspects and technical requirement. Such analysis considers various site specific parameters that include availability of infrastructure facilities such as access roads, water, distance from railheads, type of land (Government/revenue/private land); social impacts such as number of families getting affected; Common Property Resources (CPR) including feasibility of acquisition. The finalization of substation land is done based on above analysis and site visit/verification. The social aspects are provided due weightage after technical requirement in decision making for selection/finalization of land for substation. Since the lands for all the substations in the instant case are already in possession of TSECL said exercise is not required/ needed for proposed project. Details about proposed substation land have been provided in Section –5.0 (i).

SECTION - V

POTENTIAL ENVIRONMENTAL IMPACTS, THEIR EVALUATION AND MANAGEMENT

5.0 IMPACT DUE TO PROJECT LOCATION AND DESIGN

Environmental impacts of Transmission & Distribution (T & D) projects are not far reaching and are mostly localized to RoW (refer **Table- 5.1**). *Actual 132 KV line including tower on ground along with RoW and extent of impact on land/vegetation is placed as Fig.-1 & 1a*. However, T & D projects have some effects on natural and socio-culture resources. These impacts can be minimized by careful route selection. In order to get latest information and further optimization of route, modern survey techniques/tools like GIS, GPS are also applied. Introduction of GIS and GPS in route selection result in access to updated/latest information, through satellite images and further optimization of route having minimal environmental impact. Moreover, availability of various details, constraints like topographical and geotechnical details, forest and environmental details etc. help in planning the effective mitigative measures including engineering variations depending upon the site situation/location. In the instant scheme also these techniques are used and detail survey using GIS/GPS is under progress. Although, all possible measures have been taken during the finalization of route alignment for the proposed transmission lines but due to peculiarity of terrain and demography of the area where subprojects are being implemented, some environmental impacts may be there. The explanations in brief with regard to specific environment review criteria based on preliminary survey are as follows:

Table- 5.1: RoW Width & Clearance between Conductors and Trees

Transmission Voltage	Max. RoW (In Meters)	Min. Clearance (in Meters) between conductor & Trees *
132 kV	27	4.0

As per IS:5613 and MoEF guidelines finalized in consultation with CEA

(i) Resettlement

Land is required for a) construction of substations and b) erection of transmission lines. In general requirement of land area for substation varies from 0.3 acres (for 33 kV) to 10 acres (132 kV) depending upon voltage levels and no. of bays.

In the instant scheme, TSECL does not need to acquire lands for (a) because TSECL already possess land for all four proposed substations and the same is available in their existing 66 kV substation at Bagafa, Belonia, Sabroom, & Satchand. As no fresh land is needed to be acquired for these substations, issue related to acquisition of land including possible R&R is not envisaged. A sample drawing and location of proposed substations are enclosed at **Annexure- 2**.

In respect of (b), no permanent acquisition is envisaged. Land for tower and right of way is not acquired as agricultural activities can continue. A Typical plan of transmission line tower footing indicating the above position and extent of damage is depicted in **Fig.-2**.

As described earlier all measures are undertaken by TSECL at the line routing stage itself to avoid settlements such as cities, villages etc. It may be seen from the above description of proposed route alignments and also keeping in mind that no permanent acquisition of land is involved for tower foundation as per existing law, these subprojects don't require any resettlement of villagers. However, some temporary damages/disturbances can happen. Same will be compensated by the project under Compensation Plan for Temporary Damage (CPTD) to minimize the damages and provide compensation plan for temporary damages in consultation with the state government and affected persons and/ or community.

The project is being implemented in the tribal areas governed by Tripura Tribal Autonomous District Council (TTADC) as per the provisions of Sixth Schedule of the Indian Constitution. Since TTADC areas accounts for 70% of the total geographical area of the state and over 80% of the tribal population of the state the project benefit will largely accrue to tribal population therefore a separate "Tribal Peoples Development Plan" is not required.

(ii) Land value depreciation

Based on past experience land prices are generally expected to rise in the areas receiving power. Generally transmission lines pass through uninhabited area, agriculture fields and forests, where the land use is not going to change in foreseeable future. Therefore, the value of land will not be adversely affected to a significant degree.

(iii) Historical/cultural monuments/value

As per the policy of route selection, only that route alignment is finalized which avoids all the historical and cultural monuments. As per the preliminary assessment carried out during finalization of route alignment in consultation with State revenue authorities and Archaeological Survey of India (ASI), no such monuments are coming in the proposed route alignments. Moreover, utmost care shall be taken during detailed survey to avoid such areas.

(iv) Lines into precious ecological areas

As already explained all precautions have been taken to avoid routing of line through forest and protected areas like national park/sanctuaries. In spite of taking due care during route selection, involvement of some forest area could not be avoided completely. However suitable management measures as specified in EMP¹ (refer clause- 9) like minimizing RoW requirement, use of existing tower, use of tall or extended tower etc wherever feasible shall be undertaken to minimize the loss of vegetation. Moreover, protected area like wildlife sanctuary, national parks, biosphere reserves etc. have been avoided completely. However, reference in EMP is maintained to address the issues in case of any eventuality and shall be appropriately addressed during Final Environment Assessment Report (FEAR). In the instant scheme one of the line i.e. Udaipur - Bagafa 132 KV D/C which was earlier passing through Trishna Wildlife Sanctuary has been realigned at a distance of 1km from the boundary to avoid any impact on wildlife. Details of forest involvement in different lines are presented below:

¹ *Environment Management Plan (EMP) is placed at Table -6.1*

Sl. No.	Name of Transmission Line	Forest Involvement (In ha.)
1	Udaipur - Bagafa 132 KV D/C line	59.40
2	Udaipur - Amarpur 132 KV D/C line	21.33
3	Bagafa - Satchand 132 KV D/C line	13.50
4	Bagafa - Belonia 132 KV D/C line	16.55
5	Belonia - Sabroom 132 KV D/C line	35.10

It may be seen from the above table that out of total transmission line length of 139.3 km about 54 km (145.88 ha.) shall pass through forest. Prior approval of Gol/MoEF shall be obtained under Forest (Conservation) Act, 1980 after detail survey and finalization of route through forest area in consultation with local forest authorities as per well established forest clearance process described in ESPP. As per the initial study/assessment most of the forests to be traversed by the subject lines are categorised as Reserve Forest (RF) & Un-classed forest and found to be in various degree of degradation and even the wildlife species present are those who have adapted to open or disturbed habitat. It has also been confirmed by forest department that the plantation of *Tectona grandis*, *Shorea robusta*, *Terminallia bellirica* species have been carried out during last decade to enhance the density and quality of forest. Nonetheless, to mitigate losses to existing forests, clearing of the transmission line Right-of-Way will be done under supervision of forest department, and some low canopy seed trees and shrubs may be kept intact if they do not interfere with tower erection and line installation. The extracted wood will be sold by the forest department, who will also retain the sale proceeds. Three-meter wide strips of land below each conductor will be cleared during construction and one such strip shall be kept free of vegetation for maintenance purpose and regeneration up to certain height in remaining width of RoW will be allowed after construction activity. Periodical lopping/pruning of trees to maintain line clearance will be done under the direction of forest department (for details refer **Fig. - 3** for tree falling pattern and **Fig.- 3a** for area of influence). Moreover, to prevent unauthorized tree felling in forest area. measures like providing construction crews with fuel wood or alternative fuels by Contractor has been specified in EMP (refer clause- 24)

Transmission lines can serve as new access routes into previously inaccessible or poorly accessible forests, thereby accelerating forest and wildlife loss. In such cases, TSECL cannot take action itself, but local Forest Department personnel will normally assess the dangers and take appropriate action, such as establishing guard stations at the entrance to the forest etc. cost of which is borne by TSECL. Given the already easy access and degraded conditions at the proposed subprojects sites, this problem is not expected to be encountered. Nonetheless, TSECL staff will report to the Forest Department any noticeable encroachment induced by the Projects.

(v) Lines into other valuable lands

Impacts on agricultural land will be restricted to the construction phase and when large-scale maintenance measures are required. The proposed transmission line will pass mostly through agricultural fields. As per existing law, land for tower/pole and right of way is not acquired and agricultural activities are allowed to continue after construction activity and TSECL pays compensation for all damages including cost of land below tower to its owner.

In areas where transmission lines will traverse agricultural land, compensation will be paid to owners for any crop damage incurred as a result of construction activities. TSECL field staff will consult affected villagers and local revenue dept. and apprise him about the project and likely tower locations, which shall be erected in the agricultural land, for compensation. Revenue dept. after evaluating the land loss due to construction activity and crop damages based on productivity of land arrives at the compensation cost which is paid to farmer. Agricultural activities will be allowed to continue following the construction period. If bunds or other on-farm works are disturbed during construction or maintenance, they will be restored to the owner's satisfaction following cessation of construction or maintenance activities. In the event that private trees are felled during construction or maintenance operations, compensation will be paid to the owner in an amount determined by the estimated loss of products from the tree over an eight year period (for fruit bearing trees). Agricultural lands under private ownership will be identified, and in accordance with normal TSECL procedures compensation will be paid to the affected villagers (**Annexure-3**). Budgetary provision of **Rs. 461.16 lakhs** has been made in the cost estimate to meet these expenses.

(vi) **Interference with other utilities and traffic**

As per regulations enacted by Government of India, it is mandatory for TSECL to seek clearance prior to construction from department of Railways, Telecommunications and wherever necessary from aviation authorities that are likely to be affected by the construction of transmission lines. The transmission lines affect nearby telecommunication circuits by causing electrical interference. A standing committee -- Power Telecom Co-ordination Committee (P.T.C.C.) has been constituted by Government of India to plan and implement the mitigating measures for the induced voltage which may occur to nearby telecom circuit and suggest necessary protection measures to be adopted. The committee suggests measures like rerouting of the telecom circuits, conversion of overhead telecom circuits into cables etc. to minimize the interference.

The cost of such measures is determined by the Committee on the basis of prevailing norms and guidelines. Though the exact cost to mitigate the impacts of induction in neighboring telecom circuits would vary from case to case, the cost on an average works out to be Rs.50000/- per km. Provision to meet these expenses has been made in the cost estimate for the same for transmission line proposed under the instant scheme.

The main approach road for accessing the construction sites including four proposed substations is National Highway (NH) - 44 (Tripura). The volume of traffic on the NH-44 is quite low. It may be judged from the fact that this Tripura portion of NH-44 from Churaibari to Sabroom near Bangladesh border was decided to be upgraded to 4 lanes by National Highway Authority of India (NHAI) in 2007. However, due to low density of traffic, it has now been taken up for 2 laning instead of 4 laning as decided earlier. Two substations i.e. Sabroom & Satchand are situated on the main NH whereas Bagafa & Belonia substations are situated between 2-15 km from NH. Volume on these inter connected road is quite negligible as it comprises of mostly small vehicles. Therefore, we don't foresee any steep rise in volume of traffic due to mobilization for said projects.

Wherever transmission line crosses the railways, clearance is taken from that department. In general, the system is planned and executed in such a way that

adequate clearance is maintained between transmission lines on the one hand, and railways, civil aviation and defense installations on the other. Wherever the transmission lines pass by the airports the towers beyond specified height are painted in alternate orange and white stripes for easy visibility and warning lights are placed atop these towers.

(vii) Interference with drainage pattern

As the transmission lines are constructed aerially and the blockage of ground surface is limited to area of tower footings, which is very small, there is little possibility of affecting drainage pattern. Moreover, the transmission lines proposed under the subject don't not involve any tower to be placed in river beds for river crossing. However, management measures as specified in EMP (refer clause - 5 & 12) like appropriate siting of towers shall be undertaken during detailed alignment survey and design to avoid any incidence of flooding hazards of loss of agricultural production due to interference with drainage patterns or irrigation channels. In the infrequent instances where the natural flow/drainage is affected, flow will be trained and guided to safe zones. Since all proposed substations are located in plane terrain no affect on drainage of the area is envisaged particularly with adequate arrangement of drainage built in all substation design.

5.1 ENVIRONMENTAL PROBLEMS DUE TO DESIGN

(i) Escape of polluting materials

The equipments installed on lines and substations are static in nature and do not generate any fumes or waste materials. However, detailed specification with respect to equipment design and substation sewage design has been included in tender document to avoid any incidence of land and water contamination. Apart from this, solid waste like packing materials, cables, aluminium conductor, sand, aggregate material, cements and steel generated during construction is carefully handled and removed from site.

(ii) Explosion/fire hazards

During the survey and site selection for transmission lines, and substations, it has been ensured that these are kept away from oil/gas pipelines and other sites with potential for creating explosions or fires. Fires due to flashover from lines can be a more serious problem in forest. However, adequate safety measures shall be taken to avoid such incidence and has been included in EMP (refer clause - 15, 23 & 51). Besides this forest authorities also incorporate measures like making fire lines to prevent spreading of fire in the affected forest area. Apart from this, state of art safety instruments are installed in the substations on both the ends so that line gets tripped within milliseconds in case of any fault.

(iii) Erosion hazards due to inadequate provision for resurfacing of exposed area

Construction of 132kV line involves only small scale excavation of area i.e. 3m L x 3m W x 3m H for tower footing that may result in generation of 108 m³ of excavated material from each tower. In case of 132/33 kV substation foundation, excavation of soil to the tune of 7500 m³ is required depending on site condition. *It is estimated that a total*

of approx. 45360 m³ (420 X 108) and 37500 m³ (7500 x 5) of excavated materials will be generated for construction of 420 nos of tower and 5 nos. of substation respectively proposed under present scheme. However, most of these excavated materials (about 80-90%) will be used for re-filling after construction work is over and remaining materials will be disposed properly as detailed out in EMP(refer clause - 25, 26 & 28). Moreover, the topsoil disturbed during the development of sites will be stored properly and used to restore the top surface of the platform. Left over infertile and rocky material will be dumped at carefully selected dumping areas and used as fill for foundations and leveling. Hence, possibility of erosion of exposed area due to construction activity is negligible.

(iv) Environmental aesthetics

Since spacing between the towers/poles in case of 132 kV D/C transmission line is approx. 300 meters, these will not affect the visual aesthetics of the localities particularly when it is ensured to route the lines as far away from the localities as possible. TSECL takes up plantation of trees to buffer the visual effect around its substations and to provide better living conditions. Wherever TSECL feels it appropriate, discussions will be held with local Forest Department officials to determine feasibility of planting trees along roads running parallel to transmission lines to buffer visual effect in these areas. In addition, towers may be painted grey or green to merge with the background.

(v) Noise/vibration nuisances

The equipment installed at substation are mostly static and are so designed that the noise level always remains within permissible limits i.e. 85 dB as per Indian standards. The noise levels reported during normal operating conditions are about 60 to 70 dB at 2 m. distance from the equipment. To contain the noise level within the permissible limits whenever noise level increases beyond permissible limits, measures like providing sound and vibration dampers and rectification of equipment are undertaken. In addition, plantations of sound absorbing species like Casuarinas, Tamarind, and Neem are raised at the substations that reduce the sound level appreciably.

(vi) Blockage of Wildlife passage

The proposed transmission lines don't pass through any protected area and no migration paths of wildlife like elephant corridor exist near to subproject project locations hence possibility of any disturbance to wild life is not anticipated. In the instant scheme portion of 132 KV D/C Udaipur - Bagafa line passing at a distance of 1 km from the boundary of Trishna Wildlife Sanctuary will not cause any adverse impact on wildlife. The said sanctuary is situated between 23° 26.137' N and 91° 28.184' E and has an altitudinal gradient of 51–82 m. The total sanctuary area is 194.71 km² and is delimited on the east and west sides by the international boundary with Bangladesh. The forest cover of the sanctuary consists of dense primary forest (62%) dominated by *Shorea robusta*, *Dipterocarpus turbinatus*, and *Terminalia bellirica* trees, degraded forest (18%) dominated by *Toona ciliata*, *Albizia procera*, large number of shrubs, herbs and climbers, and the remaining 20% is bushy forest of bamboos (*Bambusa tulda*, *B. balcooa* and *Melocana baccifera*), sedges, long grasses (*Pennisetum purpureum* Schumach), and shrubs like *Microcos paniculata*, *Chromolaena odorata*, and *Lantana camara* among others. The sanctuary has a number of perennial water rivulets and patches of grasslands. The climatic condition is tropical, with a minimum

rainfall of 3.58 mm in December and a maximum of 508.20 mm in July. The average minimum and maximum temperature recorded in the region is 6.8° C in January and 37.70° C in June, respectively. The major fauna of this sanctuary comprises of Indian Bison (*Bos gaurus*), Wild Boar (*Sus scrofa*), Spectacle Monkey (*Trachypithecus phayrie*), Phayre's Leaf Monkey (*Presbytis phayrei*), Capped Langur (*Trachypithecus pileatus*), Slow loris (*Nycticebus coucang*), Wild Cat (*Felis chaus*), King Cobra (*Ophiophagus hannah*), Hoolock Gibbon (*Hylobates hoolock*), Leopard (*Panthera pardus*), Marbled Cat (*Felis marmorata*), Leopard Cat (*Felis bengalensis*), Golden Cat (*Felis temmincki*), Common Otter (*Lutra lutra*), Chinese Pangolin (*Manis pentadactyla*). Common bird found in Trishna include species like Pheasant tailed Jacana (*Hydrophasianus chirurgus*), Red Jungle Fowl (*Gallus gallus*), White Breasted Kingfisher (*Halcyon smyrnensis*), Indian Black drongo (*Dicrurus macrocercus*), Tailer bird (*Orthotomus sutorius*), Jungle Myna (*Acridotheres fuscus*), Parrot (*Psittacine sp*), Eagle (*Hieraatus Spilogaster*), Hornbill (*Bucerotidae sp*), Dove (*Columbidae sp*). The Sanctuary is also home for about 59 butterfly species belonging to 48 genera and 5 families. These includes species like *Papilio polytes*, *Papilio demoleus*, *Castalius rosimon*, *Eurema hecabe*, *Letha europa*, *Cepora nerissa*, *Castalius rosimon*, *Narathura selta*, *Baoris farri*, *Troides helena* and *Labadea martha*. Although such species are not going to be impacted as the proposed line is routed away from their habitat. However, for actual comprehension, the conservation status as per IUCN categorization of major species is placed as **Annexure- 4**.

The Trishna Sanctuary's important & heaviest mammal **Bison (*Bos gaurus*)** is mostly confined to its core area which is also known as Bison Reserve notified in 2007 having an area of 31.63 sq km. The proposed Udaipur-Bagafa line is 24 km approx. from this Bison Reserve in respect to its closest point to Trishna sanctuary boundary and 19 km approx from its nearest point in respect of line route (near Bagafa).). Wildlife Institute of India's geospatial map of area showing sanctuary boundary and Bison Reserve vis-à-vis line route is placed at **Map-3a**. As confirmed by Wildlife Warden of Trishna Sanctuary Bison migration/ movement is confined to Trishna core which is quite far from proposed route alignment of Bagafa line and no Bison has ever been reported from project area. Moreover, location of 3-4 towers coming at adequately safe distance from the said sanctuary shall not cause any hindrance to free passage/movement/electrocution of birds as the species reported from the sanctuary are predominantly small bird having wingspan ranging from 19-155 cm (*Pheasant tailed Jacana-19-24 cm*, *White breasted king Fisher 35-42 cm*, *Indian Eagle & Hornbill 120-155 cm*) whereas distance between two conductor is 4.6 m (460 cm) **Fig.-4** and distance between 2 tower is 300-350 m (30000-35000 cm) hence additional measures like bird guards/ diverter etc. may not be needed for proposed portion of transmission line. Further, bird hit is normally reported during landing and takeoff near the water bodies and these measures are more effective if installed in the towers coming in fly path of birds which is not in the instant case.

5.2 ENVIRONMENTAL PROBLEMS DURING CONSTRUCTION PHASE

(i) Uncontrolled silt runoff

As already explained, during construction maximum 108 m³ from each tower foundation and 7500m³ of excavated materials for each substation foundation will be generated. However, adequate measures shall be taken to store excavated materials properly for

refilling after construction is over. Further, excavation in the hilly areas is avoided in rainy days. Hence, uncontrolled silt run off is not anticipated.

(ii) Nuisance to nearby properties

As already described in preceding paras, during site selection due care is taken to keep the transmission lines and substations away from settlements. Further, all the construction activities will be undertaken through the use of small mechanical devices e.g. tractors and manual labour, therefore nuisance to the nearby properties if any, is not expected. Since all construction related activities for new substations shall be confined to existing substations which are already inaccessible for general public due to its separation/demarcation by the boundary wall. Moreover, such areas are declared as prohibited for general public as per the provisions of Electricity Act. Hence, any adverse impact arising during the construction of these substations will be temporary and limited to the boundaries of existing substations only and will neither impact nearby habitat/property nor health & safety of neighboring community.

(iii) Interference with utilities and traffic and blockage of access way

Since all the locations of subprojects are not well connected through rail link, transportation of construction materials will be mostly through road network. However, in environmental sensitive area like forest national parks, wildlife sanctuary etc. (if involved), transportation will be mostly through head load. Access to the remote sites will be along existing roads or village paths; minor improvements to paths may be made where necessary, but no major construction of roads will be necessary either during construction or as a part of maintenance procedures. In case access road/path is not available than existing field/bund may be utilized after paying due compensation for any damage to crop or field. However, in case requirement of new access road through forest area including tree felling the same will be included in forest proposal in consultation with forest department as per provisions of Forest (Conservation) Act, 1980. However, in case tree felling is not required in access road in forest area, the permission for the same will be obtained from concerned DFO in accordance with MoEF circular dt. 7th October, 2014.

As and when a transmission line crosses any road/ railways line, adequate care/caution is taken so as not to cause any hindrance to the movement of traffic. Stringing at the construction stage is carried out during lean traffic period in consultation with the concerned authorities and angle towers are planted to facilitate execution of work in different stages. Apart from this, safety precaution like barricading of work area and placement of visible signage shall be undertaken to avoid any unforeseen incident.

(iv) Inadequate resurfacing for erosion control

Since, the towers for the proposed transmission lines are to be constructed in plain area as well as hilly area due care will be taken to control erosion. If due to terrain at some points towers may be placed on slopes and erosion prone soils, internationally accepted engineering practices including bio-engineering techniques wherever feasible shall be undertaken to prevent soil erosion. This will include cutting and filling slopes wherever necessary. The back cut slopes and downhill slopes will be treated with revetments. As explained above adequate steps shall be taken to resurface the area after construction.

Wherever sites are affected by active erosion or landslides, both biological and engineering treatment will be carried out, e.g. provision of breast walls and retaining walls, and sowing soil binding grasses around the site. Further, construction is generally undertaken in dry/non-monsoon period.

(v) **Inadequate disposition of borrow area**

As mentioned earlier the transmission tower foundations involve excavations on small scale basis and the excavated soil is utilized for back filling. In case of substations generally the sites are selected in such a manner that the volume of cutting is equal to volume of filling avoiding borrowing of the area. As such acquisition/opening of borrow area is not needed.

(vi) **Protection of Worker's health/safety**

All health and safety issues and its management aspects are integral part of project/contract specific safety plan (**Annexure - 5**) which is also part of contract condition. Various aspects such as work and safety regulations, workmen's compensation, insurance are adequately covered under the General Conditions of Contract (GCC), a part of bidding documents. Project is executed as per the approved plan and is regularly monitored by dedicated Safety personnel. Moreover, for strict compliance of safety standard/plan a special provision as a deterrent has been added in the contract which provides for a heavy penalty of Rs.10 lakhs for each accidental death and Rs1.0 lakh/each for any injury and is deducted from the contractor's payment and paid to the deceased/affected family (**Annexure – 6**).

TSECL maintains safety as a top priority and has framed guidelines/checklist for workers' safety as its personnel are exposed to live EHV apparatus and transmission lines. These guidelines/checklists include work permits and safety precautions for work on the transmission lines both during construction and operation (**Annexure - 7**) and is regularly monitored by site in-charge. In addition training is imparted to the workers in fire fighting and safety measures. Standard safety tools like helmet, safety belt, gloves etc. are provided to them in accordance to the provisions of Safety Rules. First aid facilities will be made available with the labour gangs, and doctors called in from nearby towns when necessary. The number of outside (skilled) labourers will be quite small, of the order of 25-30 people per group and remaining workforce of unskilled labourers will be comprised of mostly local people. As per policy/norms preference shall be given to the eligible local labor having required skills a specific clause has been incorporated in contract conditions (refer clause- 22.2.1 of GCC) for compliance of same by Contractor. Workers are also covered by the statutory Workmen (Compensation) Act. Regular health checkups are conducted for construction workers. The construction sites and construction workers' houses will be disinfected regularly if required. In order to minimize/checking of spread of socially transmitted diseases e.g. HIV/AIDS etc. TSECL will conduct awareness building programs on such issues for the construction workers.

5.3 ENVIRONMENTAL PROBLEMS RESULTING FROM OPERATION

(i) **O&M Staff/Skills less than acceptable resulting in variety of adverse effects**

The O & M program is normally implemented by substation personnel for both the lines as well as substations. Monitoring measures employed include patrolling and thermovision scanning.

The supervisors and managers entrusted with O&M responsibilities are intensively trained for necessary skills and expertise for handling these aspects. A monthly preventive maintenance program will be carried out to disclose problems related to cooling oil, gaskets, circuit breakers, vibration measurements, contact resistance, condensers, air handling units, electrical panels and compressors. Any sign of soil erosion is also reported and rectified. Monitoring results are published monthly, including a report of corrective action taken and a schedule for future action.

TSECL follows the best international practices while designing its system to maintain acceptable prescribed EMF level. The approved international standards and design, which The ICNIRP guideline for the general public (up to 24 hours a day) is a maximum exposure level of 1,000 mG or 100 μ T. Further, because of issues relating to need to ensure health and safety relating to the line such as fire safety, safe voltages on metallic parts of buildings, and safety clearances to avoid flashover, the transmission lines will not pass directly over any residential properties and as such the potential for EMF effects to occur will be further diminished.

Poly Chlorinated Biphenyls (PCBs) due to their high heat capacity, low flammability and low electrical conductivity were extensively used as insulating material in capacitors and transformers. But after the finding that these PCBs are non-biodegradable and have carcinogenic tendency, its use in electrical equipments as insulating medium has been banned all over the world long back. However, it has been reported in some studies that chances of contamination of oil with PCB is possible. Keeping that in mind, TSECL has discontinued procurement electrical equipments containing PCB more than 2 mg/kg and specification (as per IEC 61619 or ASTM D4059) is being stated in the tender document. Moreover, the subject scheme doesn't involve replacement of any PCB containing equipment, hence no disposal of such equipment is anticipated.

5.4 CRITICAL ENVIRONMENTAL REVIEW CRITERIA

(i) Loss of irreplaceable resources

The transmission and distribution projects do not involve any large scale excavation. In transmission line land is affected to the extent 144 sq. m below the tower base for which compensation is paid to land owner. However, the subject transmission lines are passing through 54 km of forest area out of total line length 139 km. However, as per regulation, afforestation will be undertaken on double the area diverted will help in increase the forest cover.

(ii) Accelerated use of resources for short-term gains

The subprojects will not be making use of any natural resources occurring in the area during construction as well as maintenance phases. The construction material such as tower members, cement etc shall come from factories while the excavated soil shall be used for backfilling to restore the surface. During construction of transmission line very small quantity of water is required which is met from nearby existing source or through

tanker. However, for substation mostly ground water is used by installing a bore well during construction as well as for Operational stage. Moreover, provision of rain water harvesting in all proposed substations under the present scheme has been made to conserve precious water resource and enhance the ground water level. Hence it may be seen that the activities associated with implementation of subject project shall not cause any accelerated use of resources for short term gains.

(iii) **Endangering of species**

As described earlier, no endangered species of flora and fauna exist in the subprojects area is getting affected thus there is no possibility of endangering/ causing extinction of any species.

(iv) **Promoting undesirable rural-to urban migration**

The subprojects will not cause any submergence or loss of land holdings that normally trigger migration. It also does not involve acquisition of any private land holdings. Hence, there is no possibility of any migration.

5.5 PUBLIC CONSULTATION:

Public consultation/information is an integral part of the project implementation. Public is informed about the project at every stage of execution. During survey also TSECL site officials meet people and inform them about the routing of transmission lines. During the construction, every individual, on whose land tower is erected and people affected by RoW, are consulted. Apart from this, Public consultation using different technique like Public Meeting, Small Group Meeting, Informal Meeting shall also be carried out during different activities of project cycle. During such consultation the public are informed about the project in general and in particular about the following:

- Complete project plan (i.e. its route and terminating point and substations, if any, in between);
- Design standards in relation to approved international standards;
- Health impacts in relation to EMF;
- Measures taken to avoid public utilities such as school, hospitals, etc.;
- Other impacts associated with transmission lines and TSECL approach to minimizing and solving them;
- Compensation process for trees and crop damages.

Apart from organizing many informal group meetings in different villages, public meeting are organized on 15th Sep.' 2014 at Bagafa, 20th Sep.'2014 at Matabari (Udaipur) & 26th Sep.' 2014 at Satchand en-route of transmission lines covered under subject scheme. Some photographs of above consultation programmes are placed at **Plate-1**. During the public consultation programme a brochure explaining the need for implementation of subprojects also distributed among participants (**Annexure-8**). The detail of lines and its importance also explained to the villagers by the officials of TSECL and POWERGRID. The programme was arranged in interactive way and queries/concern raised by public like routing of line avoiding heavily populated area/houses, engagement of local people in construction activity etc. were replied. The Minutes of Meeting of various public consultation programmes enclosed as **Annexure- 9**. The programme was appreciated by the villagers and they assured to extend their cooperation for construction of the said

subprojects. The process of such consultation shall continue during project implementation and even during O&M stage.

5.6 CONCLUSIONS:

From the above discussion, it seems that the area is rich in natural forest resources. But careful route selection following the principle of avoidance, ecologically sensitive areas like National Park / Wildlife Sanctuaries have been avoided completely but complete avoidance of forest could not be achieved due to terrain limitations. However, all possible efforts have been taken that line route is aligned in such a way that it involves minimum forest stretch. In the instant case there is only 146 Ha forest involvement on transmission line for which adequate mitigation measure like providing funds for raising compensatory afforestation on double the area of degraded forest land shall be done by State forest department at IA's/owner cost. Moreover, to reduce the impact on forest area bare minimum felling of trees shall be done in ROW in the forest. The infrastructural constraints are very real and pose a limiting factor on the development of the area. The above facts while on the one hand underline the need for implementation of the subject scheme for overall development of the area and on another hand suggests that a detailed EIA may not be necessary as per the provisions of existing regulations.

Further, a detailed Final Environmental Assessment Report (FEAR) listing action/measures adopted for mitigation of possible environmental impact, details of environment/forest clearance, EMP implementation, monitoring details etc. after the environment/forest clearances are obtained from MoEF shall be compiled and submitted to Bank (refer **Annexure- 10** for content of FEAR).

SECTION – VI :

PROJECT IMPLEMENTATION ARRANGEMENT & MONITORING

6.0 ADMINISTRATIVE ARRANGEMENT FOR PROJECT IMPLEMENTATION:

Ministry of Power (MoP), Gol has appointed POWERGRID as Design cum Implementation Supervision Consultant (i.e. Project Management Consultant-PMC) and now redesignated as Implementing Agency (IA). However, the ownership of the assets shall be with respective State government or State Utilities, which upon progressive commissioning shall be handed over to them for taking care of Operation and Maintenance of assets. The arrangement for monitoring and reviewing of project from the perspective of environment and social management will form part of overall arrangements for project management and implementation environment. Following implementation arrangement has been proposed at different levels for smooth implementation of this project;

Central Project Implementation Unit (CPIU) - A body responsible for coordinating the preparation and implementation of the project and shall be housed within the IA's offices at Guwahati. The "Project-In-Charge" of IA & Head of each of the SPCU shall be a member of CPIU.

State Project Coordination Unit (SPCU) – A body formed by the Utility and responsible for coordinating with IA in preparing and implementing the project at the State level. It consist of experts across different areas from the Utility and shall be headed by an officer of the rank not below Chief Engineer, from the Utility.

Project Implementation Unit (PIU) – A body formed by the IA, including members of Utility on deputation, and responsible for implementing the Project across the State, with its personnel being distributed over work site & working in close association with the SPCU/ CPIU. PIU report to State level "Project Manager" nominated by the Project-in-Charge of IA. The IA will have a Core team stationed at the CPIU on permanent basis and other IA officers (with required skills) will visit as and when required by this core team. This team shall represent IA and shall be responsible for all coordination with SPCU, PIU, within IA and MoP, Gol. CPIU shall also assist MoP, Gol in monitoring project progress and in its coordination with The Bank.

6.1 REVIEW OF PROJECT IMPLEMENTATION PROGRESS:

To enable timely implementation of the project/subprojects, following committee has been setup to review the progress;

A. Joint Co-ordination Committee (JCC): IA and SPCU nominate their representatives in a body called JCC to review the project. IA shall specify quarterly milestones or targets, which shall be reviewed by JCC through a formal monthly review meeting. This meeting forum shall be called as Joint Co-ordination Committee Meeting (JCCM).The IA shall convene & keep a record of every

meeting. MoP, Gol and The Bank may join as and when needed. Minutes of the meeting will be shared with all concerned and if required, with Gol and The Bank.

- B. High Power Committee (HPC):** The Utility in consultation with its State Government shall arrange to constitute a High Power Committee (HPC) consisting of high level officials from the Utility, State/ District Administration, Law enforcement agencies, Forest Department. etc. so that various permission/ approvals/ consents/ clearances etc. are processed expeditiously so as to reach the benefits of the Project to the end consumers. HPC shall meet on bimonthly basis or earlier, as per requirement. This forum shall be called as High Power Committee Meeting (HPCM) and the SPCU shall keep a record of every meeting. Minutes of the meeting will be shared with all concerned and if required, with Gol and The Bank.
- C. Contractor's Review Meeting (CRM):** Periodic Review Meeting will be held by officials of PIU with Contractors at field offices, State Head Quarters (PIU location) and if required with core team of IA at Guwahati. These shall be called "Contractor's Review Meeting" (CRM). PIU shall keep a record of all CRMs, which shall be shared with all concerned and if required, with Gol and The Bank.
- D.** A review will be held among MoP, Gol, The Bank, State Government., Utility and IA, at four (4) months interval or earlier if needed, primarily to maintain oversight at the top level and also to debottleneck issues that require intervention at Gol/ State Government level. Minutes of the meeting shall be prepared by IA and shared with all concerned.

6.2 ENVIRONMENTAL MONITORING IN UTILITY:

Monitoring is a continuous process for TSECL projects at all the stages, be it the site selection, construction or maintenance.

The success of TSECL lies in its strong monitoring systems. Apart from the Field In-Charge reviewing the progress on daily basis regular project review meetings are held at least on monthly basis at corporate level wherein apart from construction issues the environmental aspects of the projects are discussed and remedial measures taken wherever required. The exceptions of these meetings are submitted to the Directors and Chairman and Managing Director of the Corporation. The progress of various on-going projects is also informed to the Board of Directors.

TSECL has formed a separate cell at the Circle office level namely Environment and Social Management Cell (ESMC) headed by AGM (Transmission) for proper implementation and monitoring of environmental & social management measures. TSECL organization support structure is depicted in **Exhibit - 3**. Key responsibilities of the ESMC are follows:

- Coordinating environmental and social commitments and initiatives with various multilateral agencies, GoT and MoEF.
- Coordination of all environmental activities related to a project from conceptualization to operation and maintenance stage.
- Advising and coordinating /Site office to carry out environmental and social surveys and route alignment for new projects.

- Advising site offices to follow-up with the state forest offices and other state departments for expediting forest clearances and other E & S issues of various projects.
- Providing a focal point for interaction with the MoEF for expediting forest clearances
- Training of Circle and Site officials on E & S issues arising out of Transmission/ Distribution projects and their management plan.
- Training of other departments to familiarize them with the ESPP document.

As regards monitoring of impacts on ecological resources particularly in Forest, Sanctuary or National Park, it is generally done by the concerned Divisional Forest Officer, Chief Wildlife Warden and their staff as a part of their normal duties. A detailed Environment Management Plan (EMP) including monitoring plan for all possible environmental and social impact and its proper management has been drawn (**Table-6.1**) and will be implemented during various stage of project execution. Since many provisions of EMP are to be implemented by contractor hence for proper monitoring EMP has included in the contract document. A budget estimate towards tree/crop/tower base compensation and EMP implementation is prepared and is placed at **Annexure-11**. A summary of the same is presented below:

Sr. No.	Budgetary Head	Amount (Rs. Lakhs)
1	Forest compensation	2845.00
2	Tree & Crop Compensation	426.35
3	Land Compensation for Tower Footing	34.81
4	Implementation Monitoring & Audit	34.00
	Total	3340.16

Any other measures like provision of bird guards, spike guards, barbed wire fencing or any other arrangement shall be finalized only after detailed/ check survey and finalization route alignment. Since the detailed/ check survey is part of main package such measures, its extent and estimated cost shall be incorporated in the revised cost estimate proposal which is normally prepared for all projects as there is a considerable time gap between planning and actual implementation. However, provision of additional measures like bird guards/diverter and its cost estimation need not be required in the instant scheme as no such impact are envisaged due to lines route being far away from such sensitive areas.

6.3 GRIEVANCE REDRESSAL MECHANISM (GRM)

Grievance Redress Mechanism (GRM) is an integral and important mechanism for addressing/resolving the concern and grievances in a transparent and swift manner. Many minor concerns of peoples are addressed during public consultation process initiated at the beginning of the project and broadly outlined in Annexure-23 of ESPPF. For handling grievance, TSECL has already a framework in place. To ensure its implementation, Grievance Redress Committee (GRC) will be established at two places, one at the project/scheme level and another at Corporate/HQ level. The GRCs shall include members from TSECL, Local Administration, Village Panchayat Members, Affected Persons representative and reputed persons from the society and representative from the autonomous districts council in case of tribal districts

selected/decided on nomination basis under the chairmanship of project head. The composition of GRC shall be disclosed in Panchayat office and concerned district headquarter for wider coverage.

The complainant will also be allowed to submit its complaint to local project official who will pass it to GRC immediately but not more than 5 days of receiving such complaint. The first meeting of GRC will be organized within 15 days of its constitution/disclosure to formulate procedure and frequency of meeting. However, GRC meeting shall be convened within 15 days of receiving a grievance for its solution. GRC endeavor will be to pronounce its decision/ may also refer it to corporate GRC for solution within 30-45 days of receiving grievances. In case complainant/appellant is not satisfied with the decision of GRC they can approach TSECL Corporate level Committee /District Collector or Court of law for solution.

The corporate level GRC shall function under the chairmanship of Director (Technical) who will nominate other members of GRC including one representative from corporate ESMC who is conversant with the environment & social issues. The meeting of Corporate GRC shall be convened within 7-10 days of receiving the reference from project GRC or complainant directly and pronounce its decision within next 15 days.

6.4 ENVIRONMENTAL REVIEW :

Periodic review by higher management including review by Heads of SPCU and CPIU for all environmental and social issues will be undertaken to ensure that EMP and other measures are implemented at site for compliance of agreed policy and management plan.

Table- 6.1: ENVIRONMENT MANAGEMENT PLAN²

Clause No.	Project activity/ stage	Potential impact	Proposed mitigation measures	Parameter to be monitored	Measurement & frequency	Institutional responsibility	Implementation schedule
Pre-construction							
1	Location of overhead line towers/ poles/ underground distribution lines and alignment & design	Exposure to safety related risks	Setback of dwellings to overhead line route designed in accordance with permitted level of power frequency and the regulation of supervision at sites.	Tower location and overhead/underground alignment selection with respect to nearest dwellings	Setback distances to nearest houses – once	Implementing Agency (IA)	Part of overhead lines tower/poles/ laying of underground cable sitting survey and detailed alignment survey and design
2	Equipment specifications and design parameters	Release of chemicals and gases in receptors (air, water, land)	PCBs not used in substation transformers or other project facilities or equipment.	Transformer design	Exclusion of PCBs in transformers stated in tender specification - once	IA	Part of tender specifications for the equipment
			Processes, equipment and systems not to use chlorofluorocarbons (CFCs), including halon, and their use, if any, in existing processes and systems should be phased out and to be disposed of in a manner consistent with the requirements of the Government	Process, equipment and system design	Exclusion of CFCs stated in tender specification – once Phase out schedule to be prepared in case still in use – once	IA	Part of tender specifications for the equipment Part of equipment and process design
3	Transmission/ Distribution line design	Exposure to electromagnetic interference	Line design to comply with the limits of electromagnetic interference from overhead power lines	Electromagnetic field strength for proposed line design	Line design compliance with relevant standards – once	IA	Part of design parameters

² *Compliance of these measures with quantity etc. shall be provided in the Final Environment Assessment Report (FEAR) to be prepared after obtaining all statutory clearances and execution of project”*

Clause No.	Project activity/ stage	Potential impact	Proposed mitigation measures	Parameter to be monitored	Measurement & frequency	Institutional responsibility	Implementation schedule
4	Substation location and design	Exposure to noise	Design of plant enclosures to comply with noise regulations.	Expected noise emissions based on substation design	Compliance with regulations - once	IA	Part of detailed siting survey and design
		Social inequities	Careful selection of site to avoid encroachment of socially, culturally and archaeological sensitive areas (i. g. sacred groves, graveyard, religious worship place, monuments etc.)	Selection of substation location (distance to sensitive area).	Consultation with local authorities/ autonomous councils -once		Part of detailed siting survey and design
5	Location of overhead line towers/poles/ laying of underground distribution line & alignment and design	Impact on water bodies	Avoidance of such water bodies to the extent possible. Avoidance of placement of tower inside water bodies to the extent of possible	Tower/pole location and overhead/ underground line alignment selection (distance to water bodies)	Consultation with local authorities– once	IA	Part of tower/pole sitting survey and detailed underground /overhead line alignment survey and design
		Social inequities	Careful route selection to avoid existing settlements and sensitive locations	Tower/pole location and overhead/ underground line alignment selection	Consultation with local authorities/ autonomous councils and land owners – once	IA	Part of detailed tower/pole sitting and overhead/ underground alignment survey and design
			Minimise impact on agricultural land	Tower location and overhead/underground line alignment selection (distance to agricultural land)	Consultation with local authorities/ autonomous councils and land owners – once		
			Careful selection of site and route alignment to avoid encroachment of socially, culturally and archaeological sensitive areas (i. g. sacred groves, graveyard, religious worship place, monuments etc.)	Tower/pole location and overhead/ underground line alignment selection (distance to sensitive area)	Consultation with local authorities/ autonomous councils -once		

Clause No.	Project activity/ stage	Potential impact	Proposed mitigation measures	Parameter to be monitored	Measurement & frequency	Institutional responsibility	Implementation schedule
6	Involuntary acquisition or permanent land acquisition for substation.	Social inequities	Compensation and R&R measures as per provision of RFCTLARRA,2013 ³	Compensation and monetary R&R measures implementation before possession.	As per provisions of Act.	State Govt.	Prior to award/start of substation construction.
7	Line through protected area/ precious ecological area	Loss of precious ecological values/ damage to precious species	Avoid siting into such areas by careful site and alignment selection (National Parks, Wildlife Sanctuary, Biosphere Reserves/ Biodiversity Hotspots)	Tower/pole location and overhead/ underground line alignment selection (distance to nearest designated ecological protected/ sensitive areas)	Consultation with local forest authorities - once	IA	Part of detailed siting and alignment survey /design
			Minimize the need by using RoW wherever possible	Tower/pole location and overhead/ underground line alignment selection	Consultation with local authorities and design engineers - once	IA	Part of detailed siting and alignment survey /design
8	Line through identified Elephant corridor / Migratory bird	Damage to the Wildlife/ Birds and also to line	Study of earmarked elephant corridors to avoid such corridors, Adequate ground clearance, Fault clearing by Circuit Breaker, Barbed wire wrapping on towers, reduced spans etc., if applicable	Tower/pole location and overhead/ underground line alignment selection. Minimum/maximum ground clearance	Consultation with local forest authorities – once. Monitoring – quarterly basis	IA	Part of detailed siting and alignment survey /design and Operation

³ In the instant subproject no fresh land acquisition (permanent) is involved hence this clause shall not be applicable..

Clause No.	Project activity/ stage	Potential impact	Proposed mitigation measures	Parameter to be monitored	Measurement & frequency	Institutional responsibility	Implementation schedule
			Avoidance of established/ identified migration path (Birds & Bats). Provision of flight diverter/reflectors, Bird guard, elevated perches, insulating jumper loops, obstructive perch deterrents, raptor hoods etc. ⁴ , if applicable	Tower/pole location and overhead/ underground line alignment selection	Consultation with local forest authorities - once	IA	Part of detailed sitting and alignment survey /design and Operation
9	Line through forestland	Deforestation and loss of biodiversity, edge effect	Avoid siting of line by careful site and alignment selection	Tower/pole location and overhead/ underground line alignment selection (distance to nearest protected or reserved forest)	Consultation with local authorities – once	IA	Part of detailed sitting and alignment survey/design
			Minimise the need by using existing towers, tall towers and RoW, wherever possible		Consultation with local authorities and design engineers – once		
			Measures to avoid invasion of alien species	Intrusion of invasive species	Consultation with local forest authorities - once		
			Obtain statutory clearances from the Government	Statutory approvals from Government	Compliance with regulations – once for each subproject		
			Consultation with autonomous councils wherever required	Permission/ NOC from autonomous councils	Consultation with autonomous councils – once during tower placement		

⁴ As per International/National best practices and in consultation with concerned forest/wildlife Authority

Clause No.	Project activity/ stage	Potential impact	Proposed mitigation measures	Parameter to be monitored	Measurement & frequency	Institutional responsibility	Implementation schedule
10	Lines through farmland	Loss of agricultural production/change in cropping pattern	Use existing tower or footings wherever possible	Tower/pole location and overhead/ underground line alignment selection	Consultation with local authorities and design engineers – once	IA	Part of detailed alignment survey and design
			Avoid sitting new towers on farmland wherever feasible	Tower/pole location and overhead/ underground line alignment selection	Consultation with local authorities and design engineers – once		Part of detailed sitting and alignment survey /design
11	Noise related	Nuisance to neighbouring properties	Substations sited and designed to ensure noise will not be a nuisance	Noise levels	Noise levels to be specified in tender documents – once	IA	Part of detailed equipment design
12	Interference with drainage patterns/Irrigation channels	Flooding hazards/ loss of agricultural production	Appropriate sitting of towers to avoid channel interference	Tower/pole location and overhead/ underground line alignment selection (distance to nearest flood zone)	Consultation with local authorities and design engineers – once	IA	Part of detailed alignment survey and design
13	Escape of polluting materials	Environmental pollution	Transformers designed with oil spill containment systems, and purpose-built oil, lubricant and fuel storage system, complete with spill cleanup equipment.	Equipment specifications with respect to potential pollutants	Tender document to mention specifications – once	IA	Part of detailed equipment design /drawings
			Substations to include drainage and sewage disposal systems to avoid offsite land and water pollution.	Substation sewage design	Tender document to mention detailed specifications – once	IA	Part of detailed substation layout and design /drawings
14	Equipments submerged under flood	Contamination of receptors	Substations constructed above the high flood level(HFL) by raising the foundation pad	Substation design to account for HFL (elevation with respect to HFL elevation)	Base height as per flood design- once	IA	Part of detailed substation layout and design /drawings

Clause No.	Project activity/ stage	Potential impact	Proposed mitigation measures	Parameter to be monitored	Measurement & frequency	Institutional responsibility	Implementation schedule
15	Explosions /Fire	Hazards to life	Design of substations to include modern fire fighting equipment	Substation design compliance with fire prevention and control codes	Tender document to mention detailed specifications – once	IA	Part of detailed substation layout and design /drawings
			Provision of fire fighting equipment to be located close to transformers				
Construction							
16	Equipment layout and installation	Noise and vibrations	Construction techniques and machinery selection seeking to minimize ground disturbance.	Construction techniques and machinery	Construction techniques and machinery creating minimal ground disturbance- once at the start of each construction phase	IA (Contractor through contract provisions)	Construction period
17	Physical construction	Disturbed farming activity	Construction activities on cropping land timed to avoid disturbance of field crops (within one month of harvest wherever possible).	Timing of start of construction	Crop disturbance – Post harvest as soon as possible but before next crop – once per site	IA (Contractor through contract provisions)	Construction period
18	Mechanized construction	Noise, vibration and operator safety, efficient operation	Construction equipment to be well maintained.	Construction equipment – estimated noise emissions	Complaints received by local authorities – every 2 weeks	IA (Contractor through contract provisions)	Construction period
		Noise, vibration, equipment wear and tear	Turning off plant not in use.	Construction equipment – estimated noise emissions and operating schedules	Complaints received by local authorities – every 2 weeks	IA (Contractor through contract provisions)	Construction period

Clause No.	Project activity/ stage	Potential impact	Proposed mitigation measures	Parameter to be monitored	Measurement & frequency	Institutional responsibility	Implementation schedule
19	Construction of roads for accessibility	Increase in airborne dust particles	Existing roads and tracks used for construction and maintenance access to the line wherever possible.	Access roads, routes (length and width of new access roads to be constructed)	Use of established roads wherever possible – every 2 weeks	IA (Contractor through contract provisions)	Construction period
		Increased land requirement for temporary accessibility	New access ways restricted to a single carriageway width within the RoW.	Access width (meters)	Access restricted to single carriage –way width within RoW – every 2 weeks	IA (Contractor through contract provisions)	Construction period
20	Construction activities	Safety of local villagers	Coordination with local communities for construction schedules, Barricading the construction area and spreading awareness among locals	Periodic and regular reporting /supervision of safety arrangement	No. of incidents- once every week	IA (Contractor through contract provisions)	Construction period
		Local traffic obstruction	Coordination with local authority/ requisite permission for smooth flow of traffic	Traffic flow (Interruption of traffic)	Frequency (time span)- on daily basis	IA (Contractor through contract provisions)	Construction period
21	Temporary blockage of utilities	Overflows, reduced discharge	Measure in place to avoid dumping of fill materials in sensitive drainage area	Temporary fill placement (m ³)	Absence of fill in sensitive drainage areas – every 4 weeks	IA (Contractor through contract provisions)	Construction period
22	Site clearance	Vegetation	Marking of vegetation to be removed prior to clearance, and strict control on clearing activities to ensure minimal clearance.	Vegetation marking and clearance control (area in m ²)	Clearance strictly limited to target vegetation – every 2 weeks	IA (Contractor through contract provisions)	Construction period
			No use of herbicides and pesticides				

Clause No.	Project activity/ stage	Potential impact	Proposed mitigation measures	Parameter to be monitored	Measurement & frequency	Institutional responsibility	Implementation schedule
23	Trimming /cutting of trees within RoW	Fire hazards	Trees allowed growing up to a height within the RoW by maintaining adequate clearance between the top of tree and the conductor as per the regulations.	Species-specific tree retention as approved by statutory authorities (average and max. tree height at maturity, in meters)	Presence of target species in RoW following vegetation clearance – once per site	IA (Contractor through contract provisions)	Construction period
		Loss of vegetation and deforestation	Trees that can survive pruning to comply should be pruned instead of cleared.	Species-specific tree retention as approved by statutory authorities	Presence of target species in RoW following vegetation clearance - once per site	IA (Contractor through contract provisions)	Construction period
		Felled trees and other cleared or pruned vegetation to be disposed of as authorized by the statutory bodies.	Disposal of cleared vegetation as approved by the statutory authorities (area cleared in m ²)	Use or intended use of vegetation as approved by the statutory authorities – once per site	IA (Contractor through contract provisions)	Construction period	
24	Wood/ vegetation harvesting	Loss of vegetation and deforestation	Construction workers prohibited from harvesting wood in the project area during their employment, (apart from locally employed staff continuing current legal activities)	Illegal wood /vegetation harvesting (area in m ² , number of incidents reported)	Complaints by local people or other evidence of illegal harvesting – every 2 weeks	IA (Contractor through contract provisions)	Construction period
25	Surplus earthwork/soil	Runoff to cause water pollution, solid waste disposal	Soil excavated from tower footings/ substation foundation disposed of by placement along roadsides, or at nearby house blocks if requested by landowners	Soil disposal locations and volume (m ³)	Acceptable soil disposal sites – every 2 weeks	IA (Contractor through contract provisions)	Construction period

Clause No.	Project activity/ stage	Potential impact	Proposed mitigation measures	Parameter to be monitored	Measurement & frequency	Institutional responsibility	Implementation schedule
26	Substation construction	Loss of soil	Loss of soil is not a major issue as excavated soil will be mostly reused for filling. However, in case of requirement of excess soil the same will be met from existing quarry or through deep excavation of existing pond or other nearby barren land with agreement of local communities	Borrow area sitting (area of site in m ² and estimated volume in m ³)	Acceptable soil borrow areas that provide a benefit - every 2 weeks	IA (Contractor through contract provisions)	Construction period
		Water pollution	Construction activities involving significant ground disturbance (i.e. substation land forming) not undertaken during the monsoon season	Seasonal start and finish of major earthworks(P ^H , BOD/ COD, Suspended solids, others)	Timing of major disturbance activities –prior to start of construction activities	IA (Contractor through contract provisions)	Construction period
27	Site clearance	Vegetation	Tree clearances for easement establishment to only involve cutting trees off at ground level or pruning as appropriate, with tree stumps and roots left in place and ground cover left undisturbed	Ground disturbance during vegetation clearance (area, m ²)	Amount of ground disturbance – every 2 weeks	IA (Contractor through contract provisions)	Construction period
				Statutory approvals	Statutory approvals for tree clearances – once for each site		
28	Substation foundation/ Tower erection disposal of surplus earthwork/fill	Waste disposal	Excess fill from substation/tower foundation excavation disposed of next to roads or around houses, in agreement with the local community or landowner	Location and amount (m ³)of fill disposal	Appropriate fill disposal locations – every 2 weeks	IA (Contractor through contract provisions)	Construction period

Clause No.	Project activity/ stage	Potential impact	Proposed mitigation measures	Parameter to be monitored	Measurement & frequency	Institutional responsibility	Implementation schedule
29	Storage of chemicals and materials	Contamination of receptors (land, water, air)	Fuel and other hazardous materials securely stored above high flood level.	Location of hazardous material storage; spill reports (type of material spilled, amount (kg or m ³) and action taken to control and clean up spill)	Fuel storage in appropriate locations and receptacles – every 2 weeks	IA (Contractor through contract provisions)	Construction period
30	Construction schedules	Noise nuisance to neighbouring properties	Construction activities only undertaken during the day and local communities informed of the construction schedule.	Timing of construction (noise emissions, [dB(A)])	Daytime construction only – every 2 weeks	IA (Contractor through contract provisions)	Construction period
31	Provision of facilities for construction workers	Contamination of receptors (land, water, air)	Construction workforce facilities to include proper sanitation, water supply and waste disposal facilities.	Amenities for Workforce facilities	Presence of proper sanitation, water supply and waste disposal facilities – once each new facility	IA (Contractor through contract provisions)	Construction period
32	Influx of migratory workers	Conflict with local population to share local resources	Using local workers for appropriate asks	Avoidance/reduction of conflict through enhancement/ augmentation of resource requirements	Observation & supervision–on weekly basis	IA (Contractor through contract provisions)	Construction period
33	Lines through farmland	Loss of agricultural productivity	Use existing access roads wherever possible	Usage of existing utilities	Complaints received by local people /authorities - every 4 weeks	IA (Contractor through contract provisions)	Construction period
			Ensure existing irrigation facilities are maintained in working condition	Status of existing facilities			
			Protect /preserve topsoil and reinstate after construction completed	Status of facilities (earthwork in m ³)			

Clause No.	Project activity/ stage	Potential impact	Proposed mitigation measures	Parameter to be monitored	Measurement & frequency	Institutional responsibility	Implementation schedule
			Repair /reinstate damaged bunds etc after construction completed	Status of facilities (earthwork in m ³)			
		Social inequities	Land owners/ Farmers compensated for any temporary loss of productive land as per existing regulation.	Process of Crop/tree compensation in consultation with forest dept.(for timber yielding tree) and Horticulture deptt.(for fruit bearing tree)	Consultation with affected land owner prior to implementation and during execution.	IA	During construction
34	Uncontrolled erosion/silt runoff	Soil loss, downstream siltation	Need for access tracks minimised, use of existing roads. Limit site clearing to work areas Regeneration of vegetation to stabilise works areas on completion (where applicable) Avoidance of excavation in wet season Water courses protected from siltation through use of bunds and sediment ponds	Design basis and construction procedures (suspended solids in receiving waters; area re-vegetated in m ² ; amount of bunds constructed [length in meter, area in m ² , or volume in m ³])	Incorporating good design and construction management practices – once for each site	IA (Contractor through contract provisions)	Construction period
35	Nuisance to nearby properties	Losses to neighbouring land uses/ values	Contract clauses specifying careful construction practices. As much as possible existing access ways will be used	Contract clauses Design basis and layout	Incorporating good construction management practices – once for each site Incorporating good design engineering practices– once for each site	IA (Contractor through contract provisions)	Construction period

Clause No.	Project activity/ stage	Potential impact	Proposed mitigation measures	Parameter to be monitored	Measurement & frequency	Institutional responsibility	Implementation schedule
			Productive land will be reinstated following completion of construction	Reinstatement of land status (area affected, m ²)	Consultation with affected parties – twice – immediately after completion of construction and after the first		
		Social inequities	Compensation will be paid for loss of production, if any.	Implementation of Tree/Crop compensation (amount paid)	Consultation with affected parties – once in a quarter	IA	Prior to construction
36	Flooding hazards due to construction impediments of natural drainage	Flooding and loss of soils, contamination of receptors (land, water)	Avoid natural drainage pattern/ facilities being disturbed/blocked/ diverted by ongoing construction activities	Contract clauses (e.g. suspended solids and BOD/COD in receiving water)	Incorporating good construction management practices-once for each site	IA (Contractor through contract provisions)	Construction period
37	Equipment submerged under flood	Contamination of receptors (land, water)	Equipment stored at secure place above the high flood level(HFL)	Store room level to be above HFL (elevation difference in meters)	Store room level as per flood design-once	IA	Construction period
38	Inadequate siting of borrow areas (quarry areas)	Loss of land values	Existing borrow sites will be used to source aggregates, therefore, no need to develop new sources of aggregates	Contract clauses	Incorporating good construction management practices – once for each site	IA (Contractor through contract provisions)	Construction period
39	Health and safety	Injury and sickness of workers and members of the public	Safety equipment's (PPEs) for construction workers Contract provisions specifying minimum requirements for construction camps Contractor to prepare and implement a health and safety plan.	Contract clauses (number of incidents and total lost-work days caused by injuries and sickness)	Contract clauses compliance – once every quarter	IA (Contractor through contract provisions)	Construction period

Clause No.	Project activity/ stage	Potential impact	Proposed mitigation measures	Parameter to be monitored	Measurement & frequency	Institutional responsibility	Implementation schedule
			Contractor to arrange for health and safety training sessions				
40	Inadequate construction stage monitoring	Likely to maximise damages	Training of environmental monitoring personnel	Training schedules	Number of programs attended by each person – once a year	IA	Routinely throughout construction period
			Implementation of effective environmental monitoring and reporting system using checklist of all contractual environmental requirements	Respective contract checklists and remedial actions taken thereof.	Submission of duly completed checklists of all contracts for each site - once		
			Appropriate contract clauses to ensure satisfactory implementation of contractual environmental mitigation measures.	Compliance report related to environmental aspects for the contract	Submission of duly completed compliance report for each contract – once		
Operation and Maintenance							
41	Location of line towers/poles and overhead/ underground line alignment & design	Exposure to safety related risks	Setback of dwellings to overhead line route designed in accordance with permitted level of power frequency and the regulation of supervision at sites.	Compliance with setback distances (“as-built” diagrams)	Setback distances to nearest houses – once in quarter	TSECL	During operations
42	Line through identified bird flyways, migratory path	Injury/ mortality to birds, bats etc due to collision and electrocution	Avoidance of established/ identified migration path (Birds & Bats). Provision of flight diverter/reflectors, elevated perches, insulating jumper loops, obstructive perch deterrents, raptor hoods etc., if applicable	Regular monitoring for any incident of injury/mortality	No. of incidents- once every month	TSECL	Part of detailed siting and alignment survey /design and Operation
43	Equipment submerged under flood	Contamination of receptors (land, water)	Equipment installed above the high flood level (HFL) by raising the foundation pad.	Substation design to account for HFL (“as-built”	Base height as per flood design – once	TSECL	During operations

Clause No.	Project activity/ stage	Potential impact	Proposed mitigation measures	Parameter to be monitored	Measurement & frequency	Institutional responsibility	Implementation schedule
				diagrams)			
44	Oil spillage	Contamination of land/nearby water bodies	Substation transformers located within secure and impervious sump areas with a storage capacity of at least 100% of the capacity of oil in transformers and associated reserve tanks.	Substation bunding (Oil sump) (“as-built” diagrams)	Bunding (Oil sump) capacity and permeability - once	TSECL	During operations
45	SF6 management	Emission of most potent GHG causing climate change	Reduction of SF6 emission through awareness, replacement of old seals, proper handling & storage by controlled inventory and use, enhance recovery and applying new technologies to reduce leakage	Leakage and gas density/level	Continuous monitoring	TSECL	During Operations
46	Inadequate provision of staff/workers health and safety during operations	Injury and sickness of staff /workers	Careful design using appropriate technologies to minimise hazards	Usage of appropriate technologies (lost work days due to illness and injuries)	Preparedness level for using these technologies in crisis – once each year	TSECL	Design and operation
			Safety awareness raising for staff.	Training/awareness programs and mock drills	Number of programs and percent of staff /workers covered – once each year		
			Preparation of fire emergency action plan and training given to staff on implementing emergency action plan	Provision of facilities	Complaints received from staff /workers every 2 weeks		
47	Electric Shock Hazards	Injury/ mortality to staff and public	Careful design using appropriate technologies to minimise hazards	Usage of appropriate technologies (no. of injury incidents, lost work days)	Preparedness level for using these technology in crisis – once a month	TSECL	Design and Operation

Clause No.	Project activity/ stage	Potential impact	Proposed mitigation measures	Parameter to be monitored	Measurement & frequency	Institutional responsibility	Implementation schedule
			Security fences around substations	Maintenance of fences	Report on maintenance – every 2 weeks		
			Barriers to prevent climbing on/ dismantling of transmission	Maintenance of barriers			
			Appropriate warning signs on facilities	Maintenance of warning signs	Number of programs and percent of total persons covered – once each year		
			Electricity safety awareness raising in project areas	Training /awareness programs and mock drills for all concerned parties			
48	Operations and maintenance staff skills less than acceptable	Unnecessary environmental losses of various types	Adequate training in O&M to all relevant staff of substations & transmission/distribution line maintenance crews. Preparation and training in the use of O&M manuals and standard operating practices	Training/awareness programs and mock drills for all relevant staff	Number of programs and percent of staff covered – once each year	TSECL	Operation
49	Inadequate periodic environmental monitoring.	Diminished ecological and social values.	Staff to receive training in environmental monitoring of project operations and maintenance activities.	Training/awareness programs and mock drills for all relevant staff	Number of programs and percent of staff covered – once each year	TSECL	Operation
50	Equipment specifications and design parameters	Release of chemicals and gases in receptors (air, water, land)	Processes, equipment and systems using cholofluorocarbons (CFCs), including halon, should be phased out and to be disposed of in a manner consistent with the requirements of the Govt.	Process, equipment and system design	Phase out schedule to be prepared in case still in use – once in a quarter	TSECL	Operations
51	Transmission/ distribution line maintenance	Exposure to electromagnetic interference	Transmission/ distribution line design to comply with the limits of electromagnetic interference from overhead power lines	Required ground clearance (meters)	Ground clearance - once	TSECL	Operations

Clause No.	Project activity/ stage	Potential impact	Proposed mitigation measures	Parameter to be monitored	Measurement & frequency	Institutional responsibility	Implementation schedule
52	Uncontrolled growth of vegetation	Fire hazard due to growth of tree/shrub /bamboo along RoW	Periodic pruning of vegetation to maintain requisite electrical clearance. No use of herbicides/pesticides	Requisite clearance (meters)	Assessment in consultation with forest authorities - once a year(pre-monsoon/post-monsoon)	TSECL	Operations
53	Noise related	Nuisance to neighbouring properties	Substations sited and designed to ensure noise will not be a nuisance.	Noise levels {dB(A)}	Noise levels at boundary nearest to properties and consultation with affected parties if any - once	TSECL	Operations

EXHIBIT - 1
POWER MAP OF TRIPURA

POWER MAP OF TRIPURA

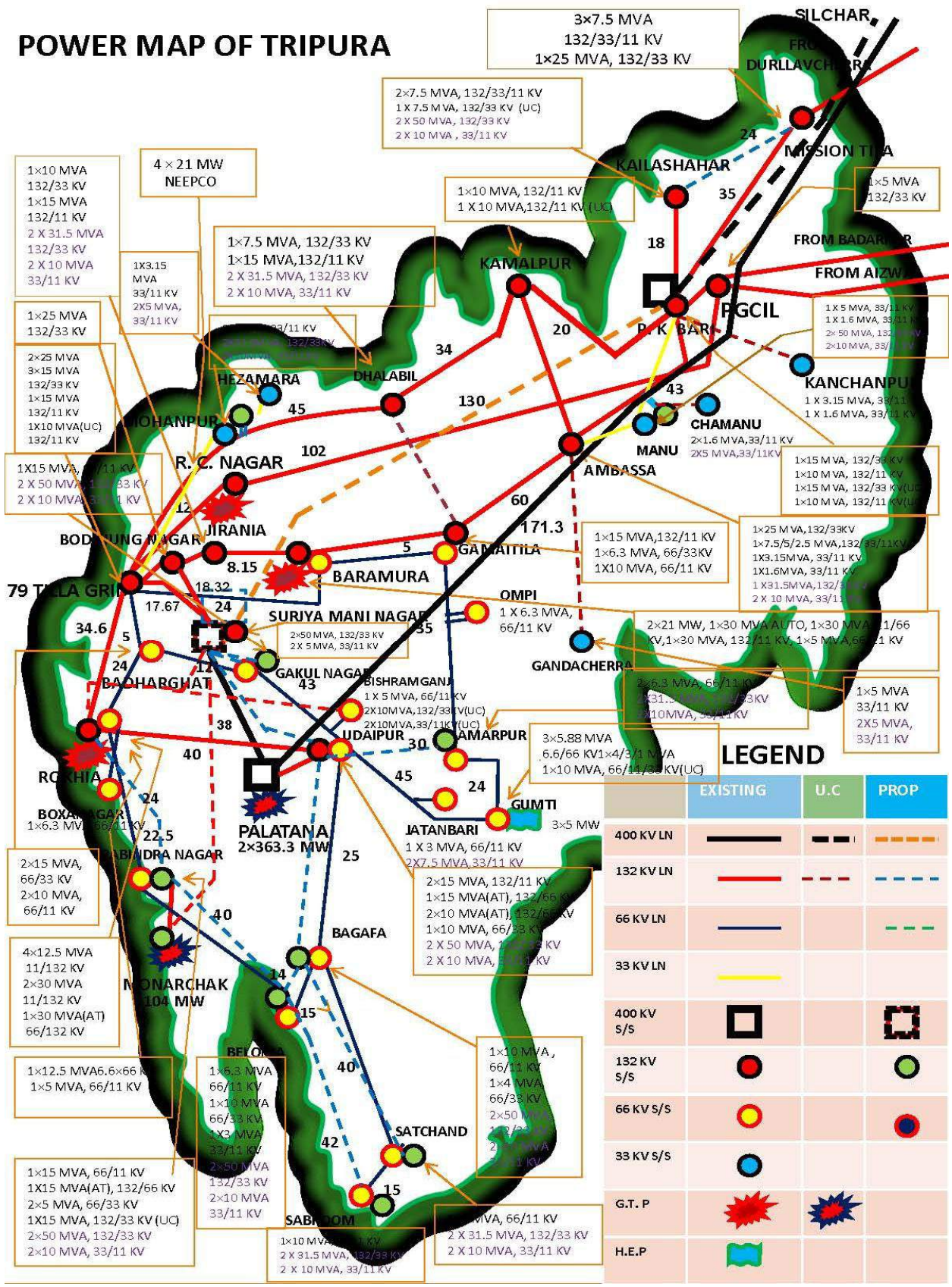

LEGEND

	EXISTING	U.C.	PROP
400 KV LN			
132 KV LN			
66 KV LN			
33 KV LN			
400 KV S/S			
132 KV S/S			
66 KV S/S			
33 KV S/S			
G.T. P			
H.E.P			

EXHIBIT - 2

***SCHEMATIC MAP SHOWING PROPOSED
TRANSMISSION NETWORK***

Schematic Map Showing proposed Transmission Network in Gumti & South Tripura District under NER Power System Improvement Project in TRIPURA

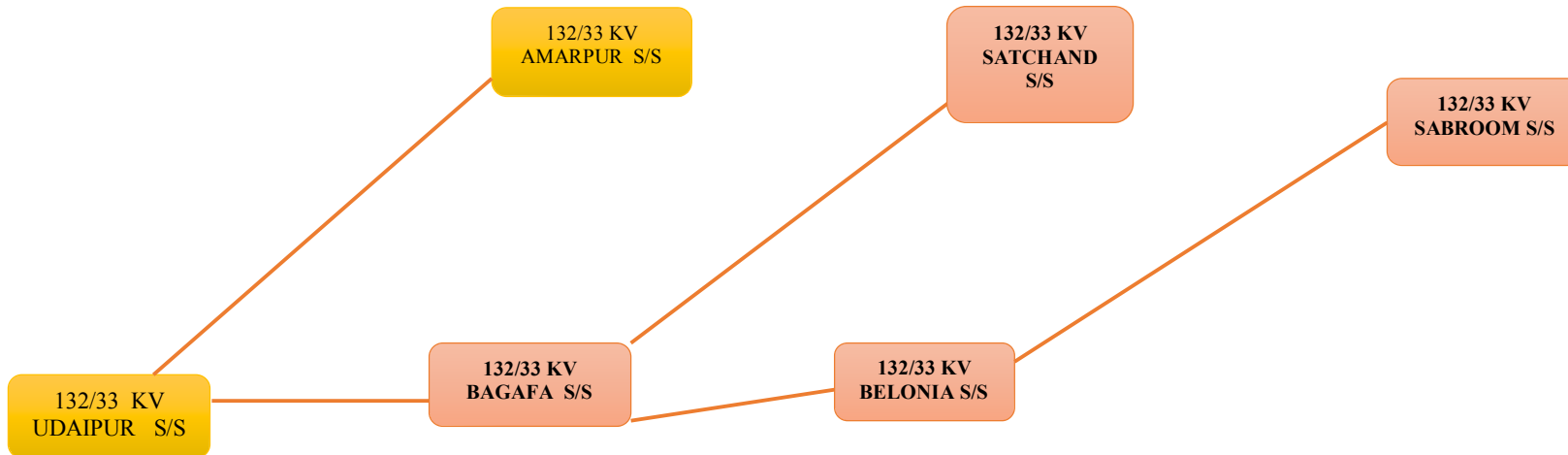
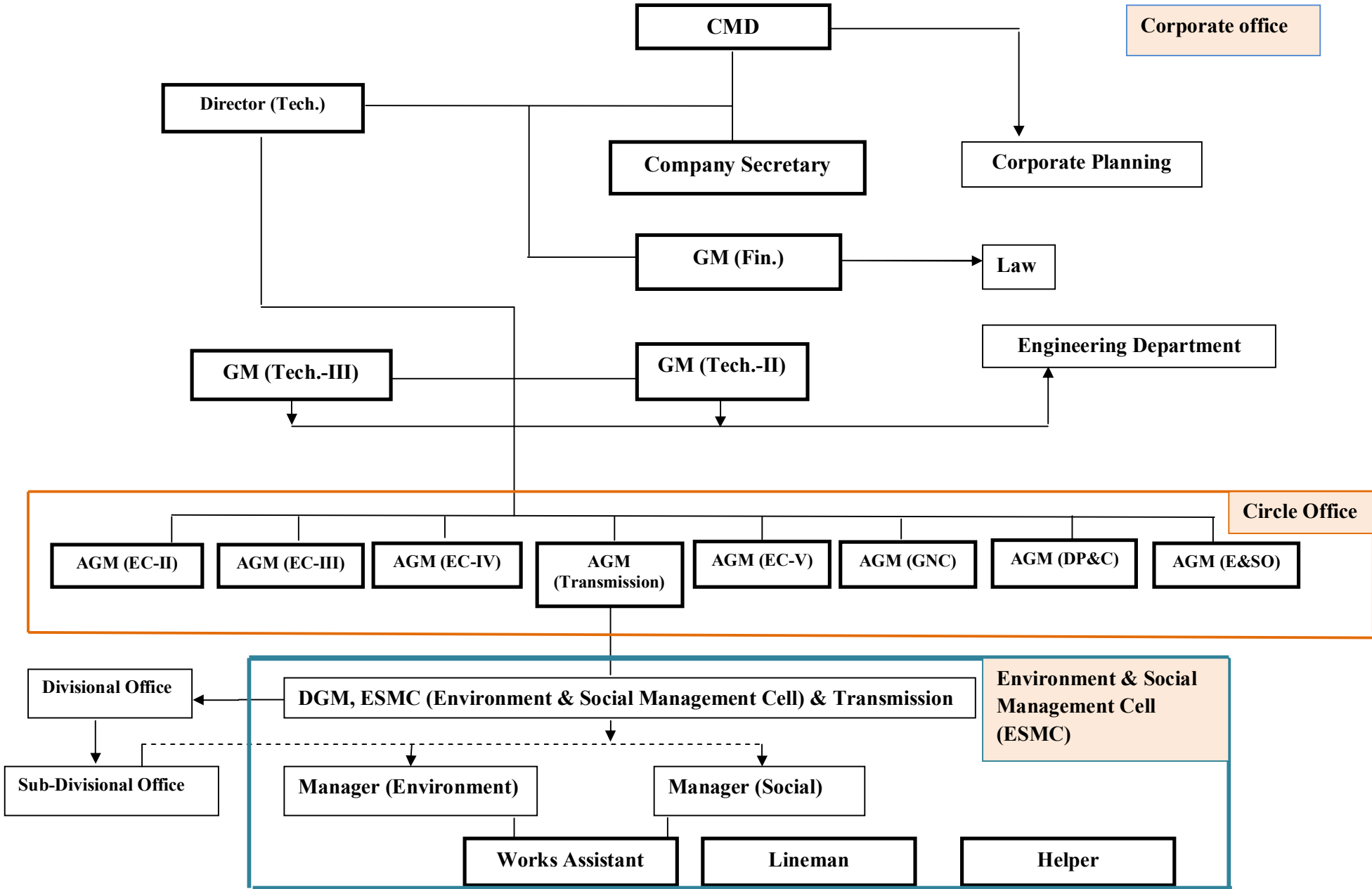

EXHIBIT – 3

***TSECL'S ORGANIZATION SUPPORT
STRUCTURE***

TSECL's Organization Support Structure for ESPPF



MAP - 1
FOREST COVER MAP OF TRIPURA

FOREST COVER IN TRIPURA

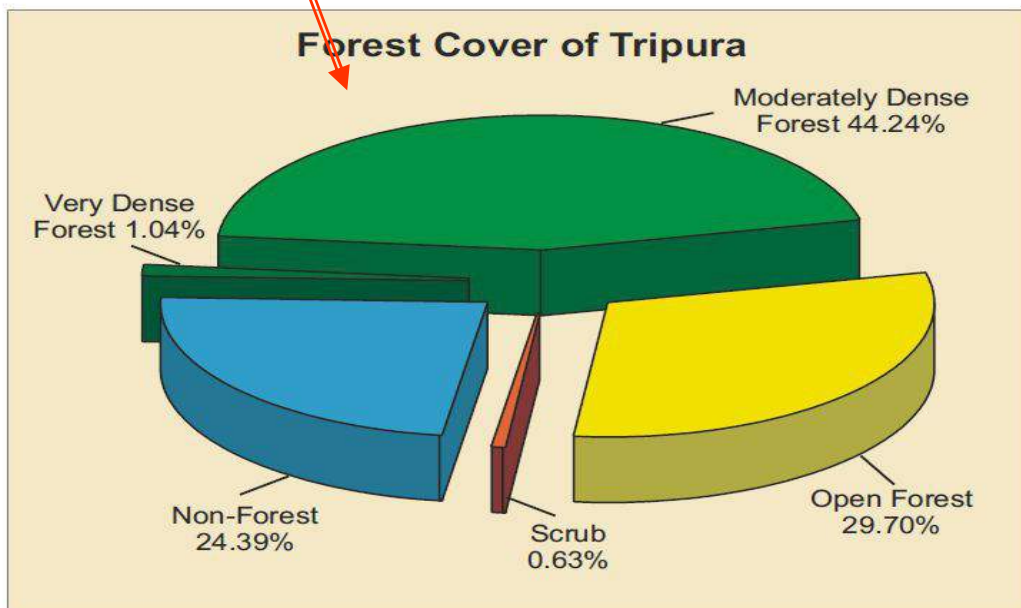
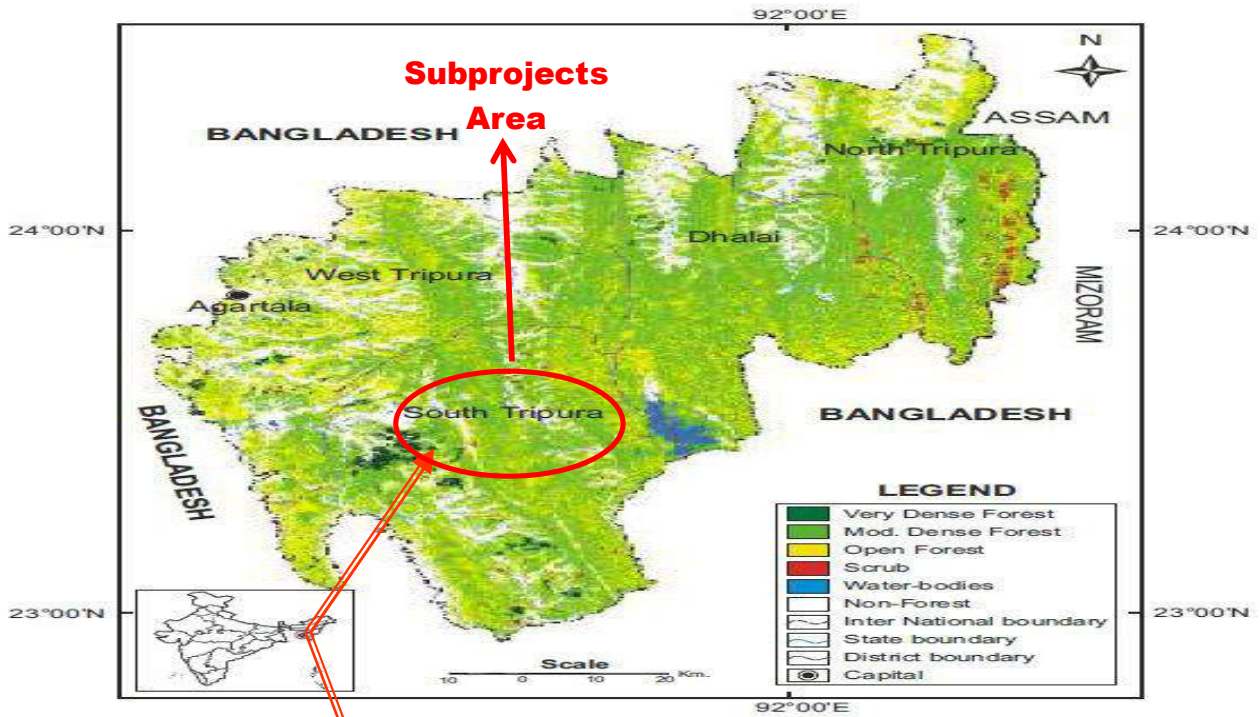

MAP - 3

***IBAT MAP SUPERIMPOSING FOR 132 KV D/C
UDAIPUR -BAGAFA TR. LINE***

- ALT-2 RUPAI CHAPAKH...
- ALT-2 RUPAI CHAPAKH...
- PAKKE 1
- Pakke 2
- Untitled Image Overlay
- Untitled Image Overlay
- Untitled Image Overlay
- 17.85 kms
- 1.53 KMS
- 0.9 KMS
- Earth Point Excel To KML
for Aviation send to ATS.xls
- Sheet1
- 132 KV Udaipur-Bagafa T...
- 1.99 Km
- 132 KV Udaipur-Bagafa T...
- 3.28 kms
- 2.65 kms
- Untitled Image Overlay
- Temporary Places

- Primary Database
- Borders and Labels
- Places
- Photos
- Roads
- 3D Buildings
- Ocean
- Weather
- Gallery
- Global Awareness
- More

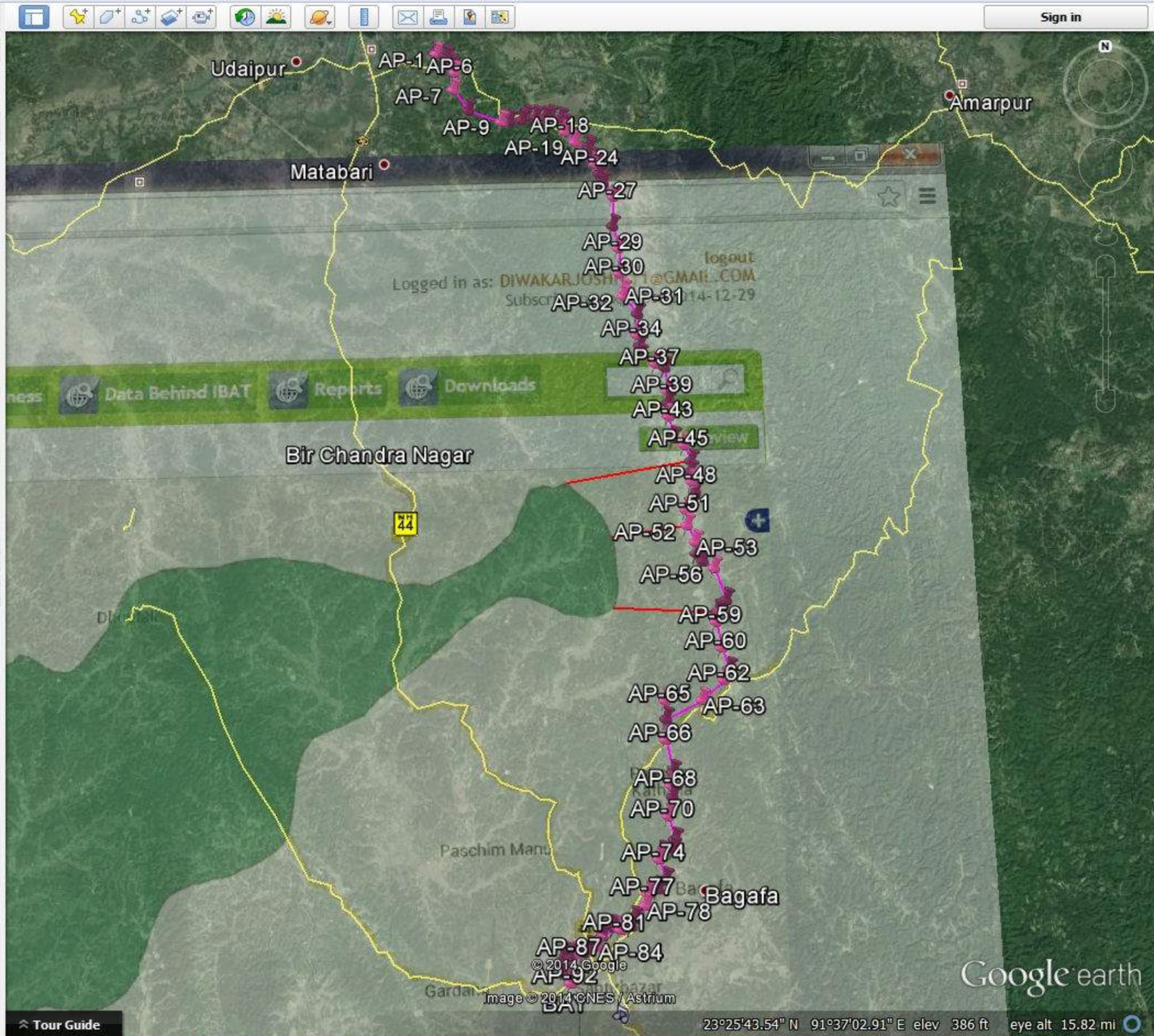

MAP – 3 a

***GEOSPATIAL MAP OF AREA SHOWING
SANCTUARY BOUNDARY AND BISON
RESERVE VIS-À-VIS 132 KV D/C UDAIPUR –
BAGAFA LINE ROUTE***

TRISHNA SANCTUARY

PROPOSED ROUTE D¹ ALIGNMENT OF UDAIPUR - BAGAFATA 132 KV D/L LINE

24 KM APPROX.

19 KM APPROX.

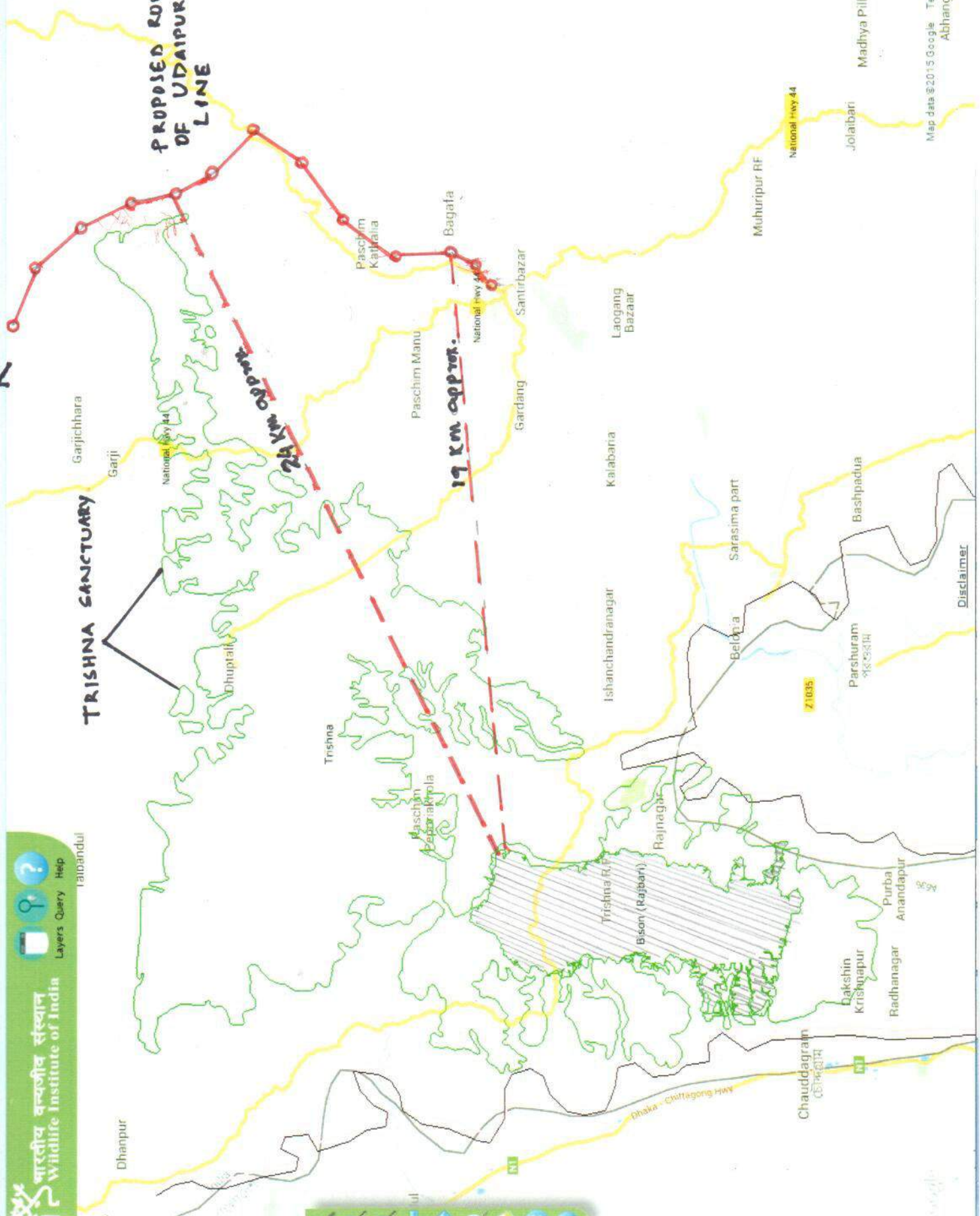

FIGURE - 1

***132 KV LINE DEPICTING ACTUAL POSITION
ALONG WITH ROW AND EXTENT OF
DAMAGE***

132 kV line depicting actual position along with RoW and extent of damage



FIGURE - 1 a

***132 KV TOWER BASE SHOWING IMPACT
ON AGRICULTURAL LAND AND CROP***

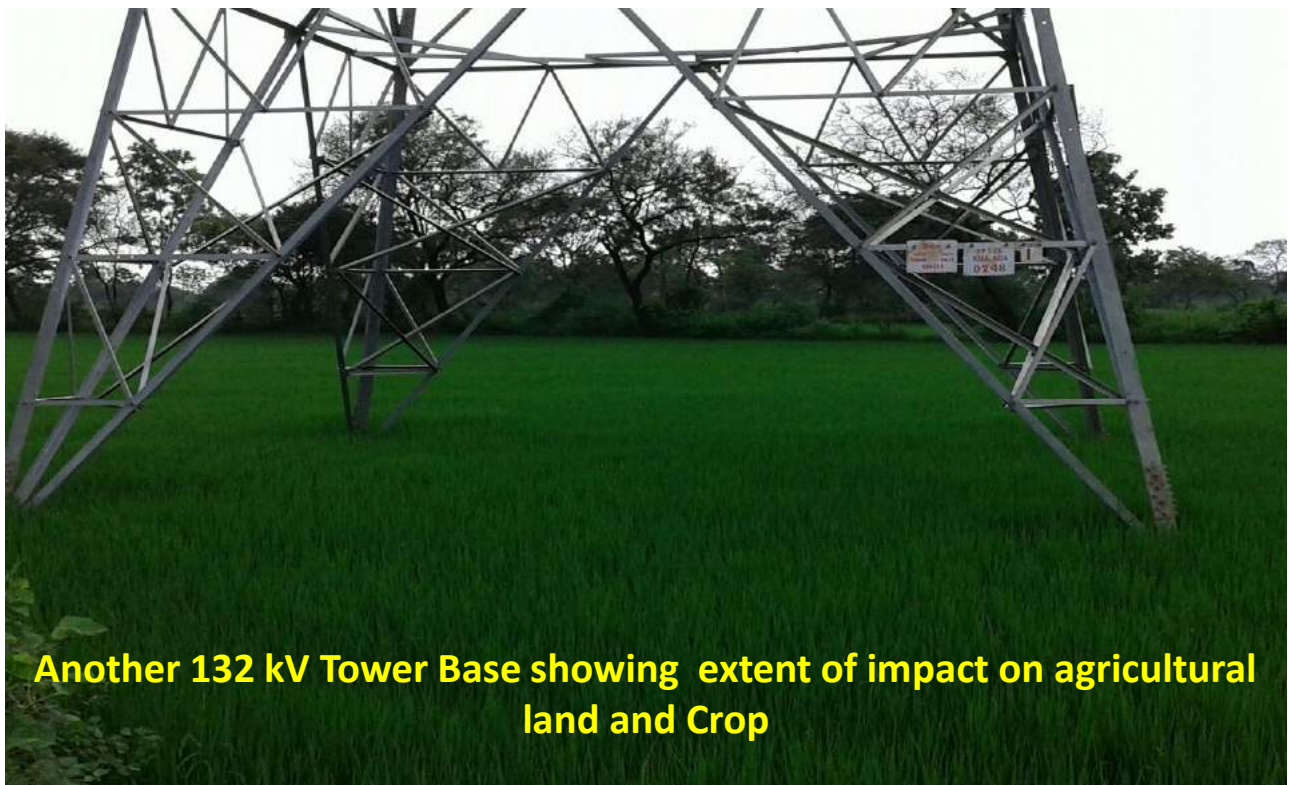
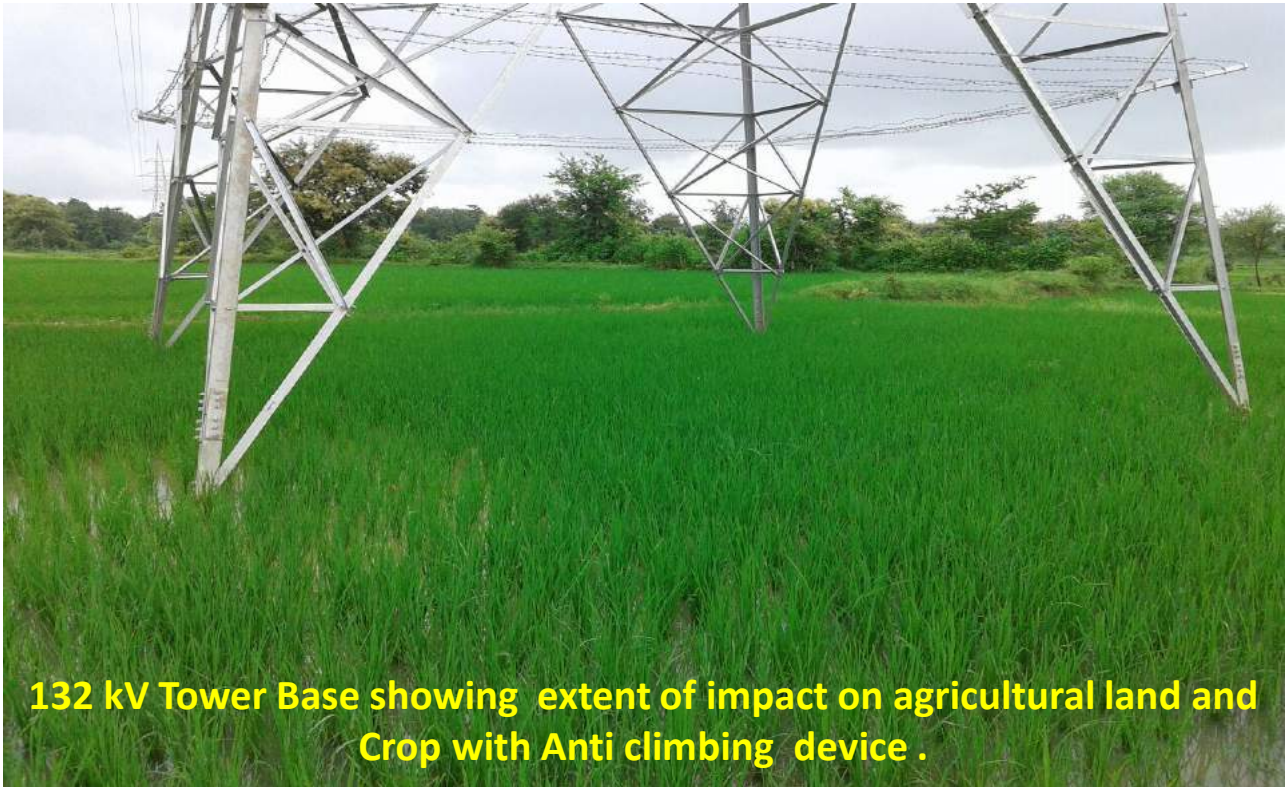
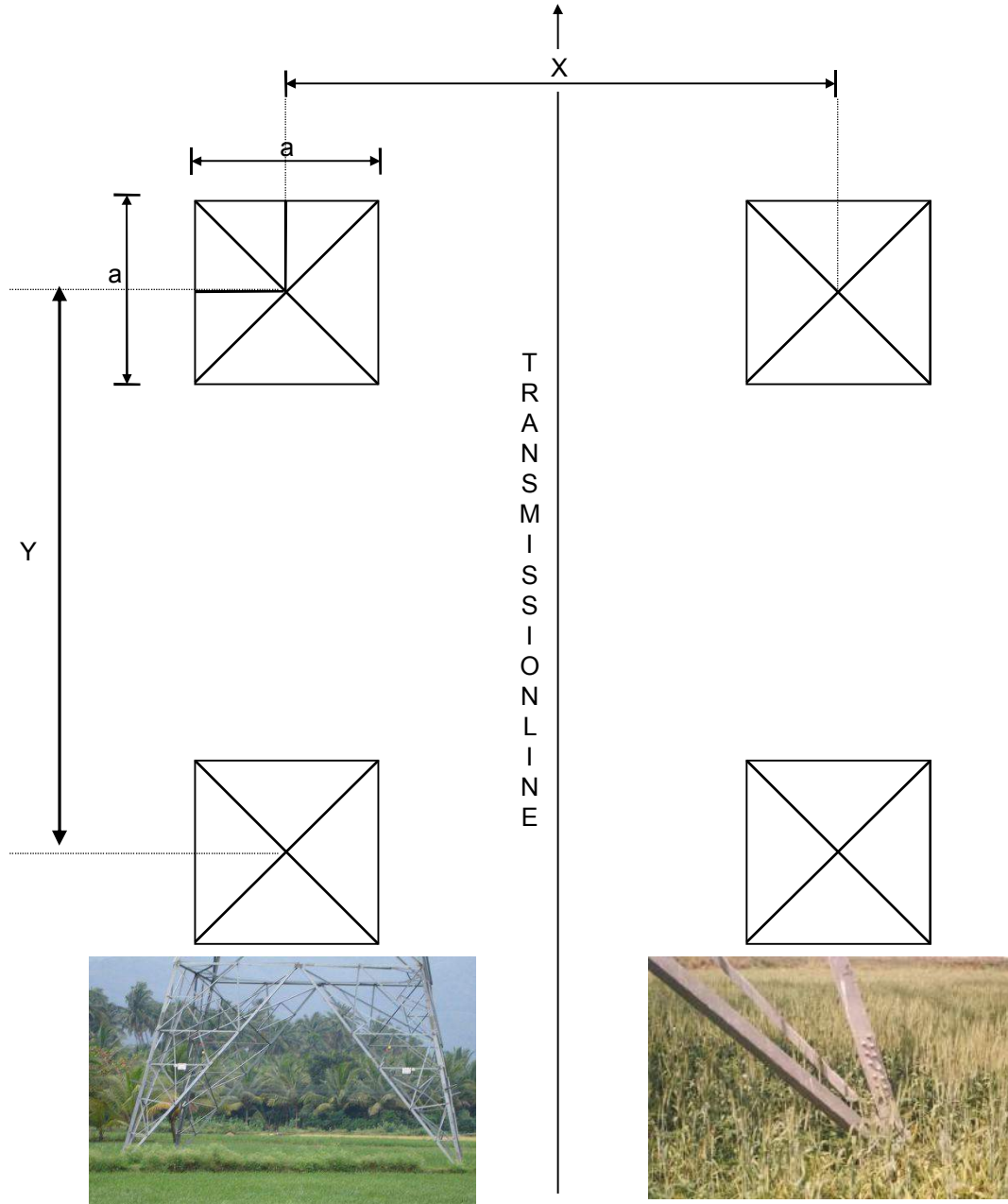

FIGURE - 2

***TYPICAL PLAN OF TRANSMISSION LINE
TOWER FOOTING INDICATING THE ABOVE
POSITION AND EXTENT OF DAMAGE***

**TYPICAL PLAN OF TRANSMISSION LINE TOWER FOOTINGS
SHOWING ACTUAL GROUND POSITION AND EXTENT OF IMPACT**



ACTUAL POSITION ON GROUND

INDICATIVE MEASURES

X & Y = 10-15 METERS

a = 300- 450 mm

FIGURE - 3

***TREE FELLING PATTERN IN FOREST IN
132 KV D/C LINE***

TREE FELLING PATTERN IN FOREST FOR 132 KV D/C

DURING CONSTRUCTION

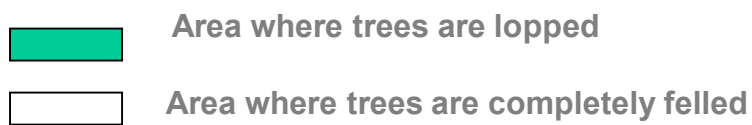
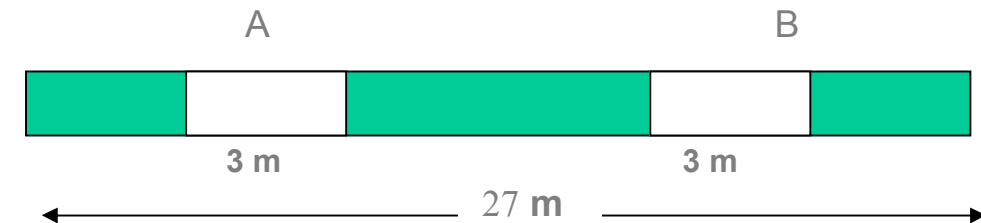

AFTER CONSTRUCTION

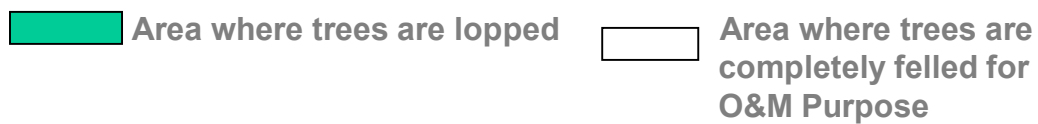
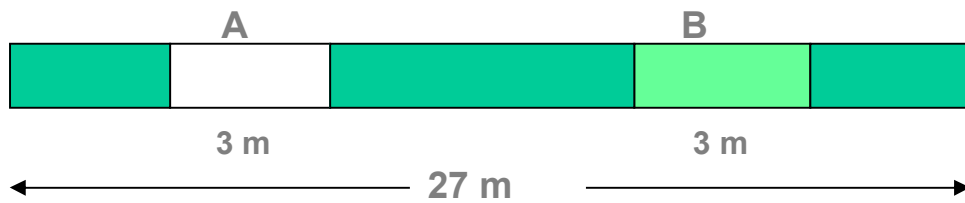

FIGURE - 3 a

***SCHEMATIC DIAGRAM INDICATING AREA OF
INFLUENCE/IMPACT FOR 132 KV D/C
TRANSMISSION LINE***

POWER GRID CORPORATION OF INDIA LIMITED

(A Government Of India Enterprise)

SCHEMATIC DIAGRAM FOR INDICATING AREA OF INFLUENCE/IMPACT for 132 KV D/C Transmission Line

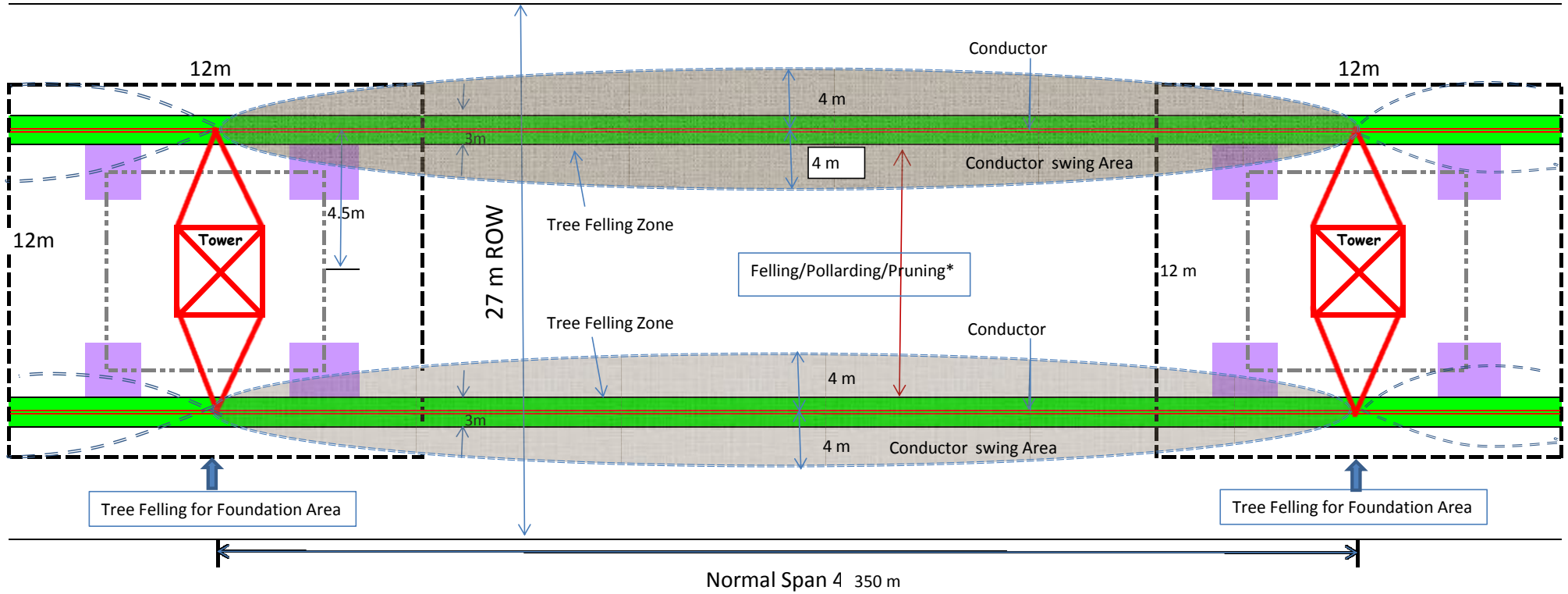
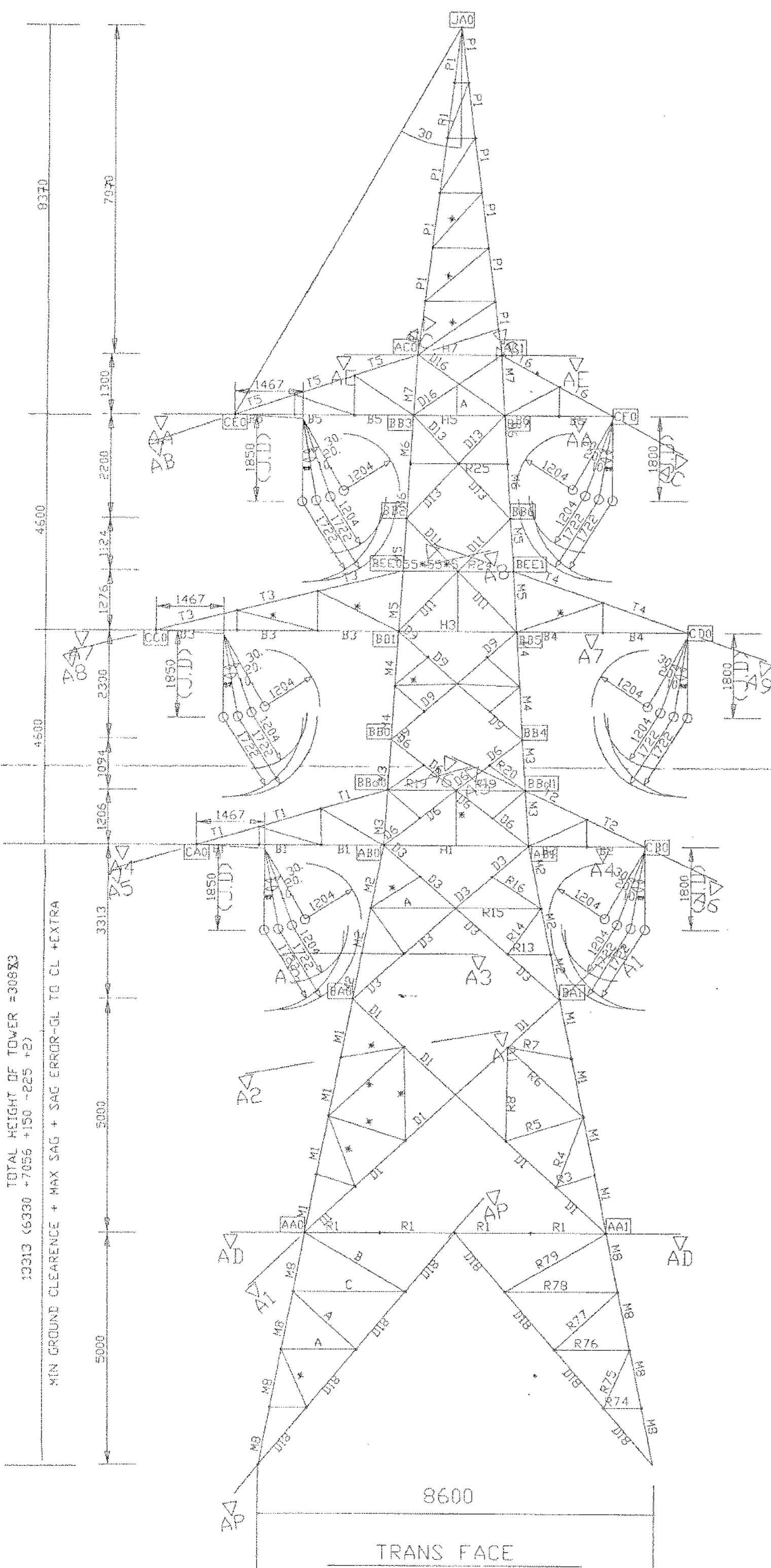

FIGURE - 4

DIAGRAM OF 132 KV D/C TOWER DESIGN



TOWER COMBINATIONS

TOWER TYPE	TOWER COMBINATION
NT -3.0 M	BASIC BODY + 4XC->3.0M LEG EXTENSIONS
NT -1.5 M	BASIC BODY + 4XC->1.5M LEG EXTENSIONS
NT +1.0 M	BASIC BODY + 4XC->1.0M LEG EXTENSIONS
NT +1.5 M	BASIC BODY + 4XC->1.5M LEG EXTENSIONS
NT +3.0 M	BASIC BODY+08E+4XC->3.0M LEG EXTENSIONS
NT +4.5 M	BASIC BODY+08E+4XC->4.5M LEG EXTENSIONS
NT +6.0 M	BASIC BODY+08E+4XC->6.0M LEG EXTENSIONS
NT +7.5 M	BASIC BODY+08E+4XC->7.5M LEG EXTENSIONS
NT +9.0 M	BASIC BODY+08E+4XC->9.0M LEG EXTENSIONS

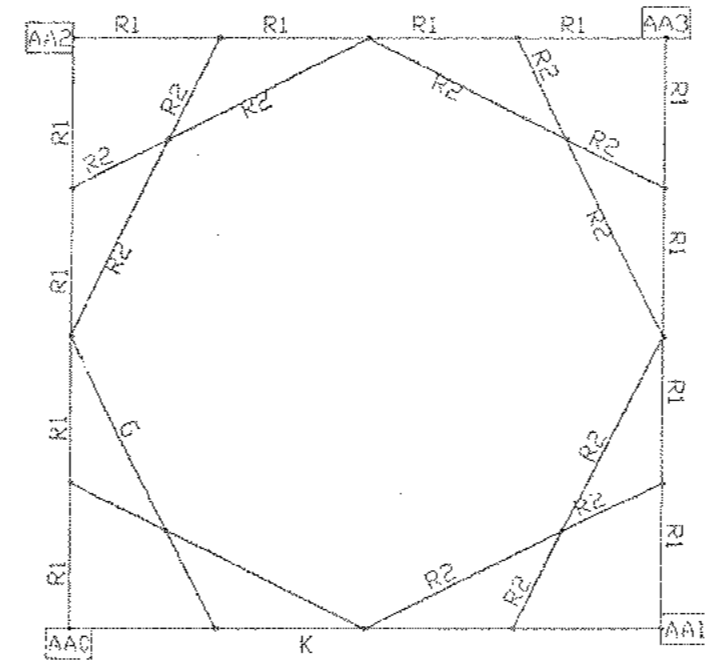
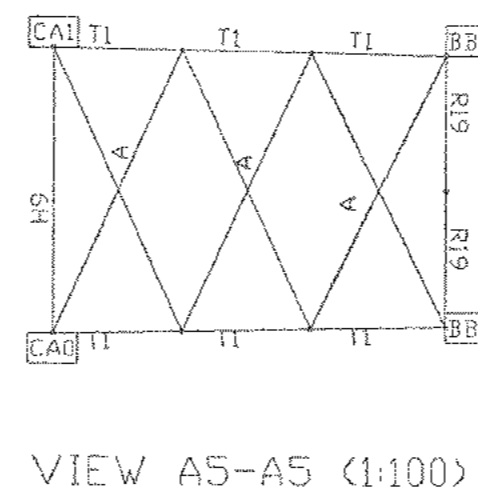
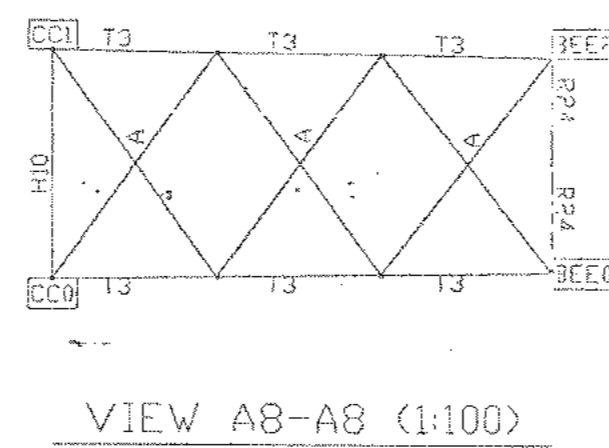
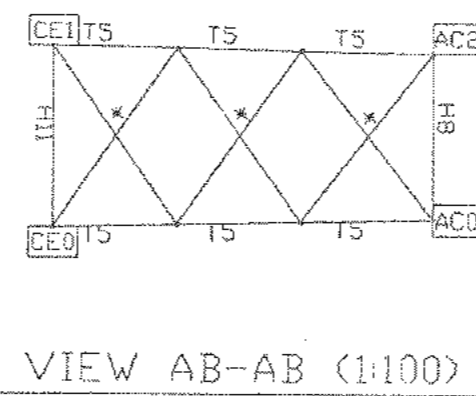
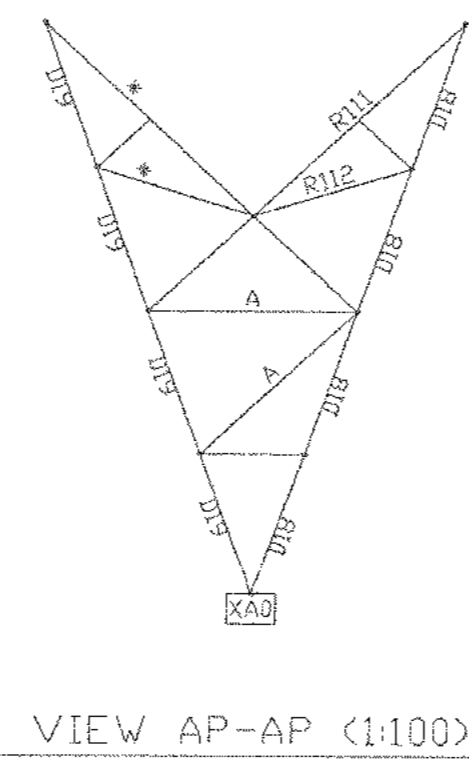

VIEW AD-AD (1:100)

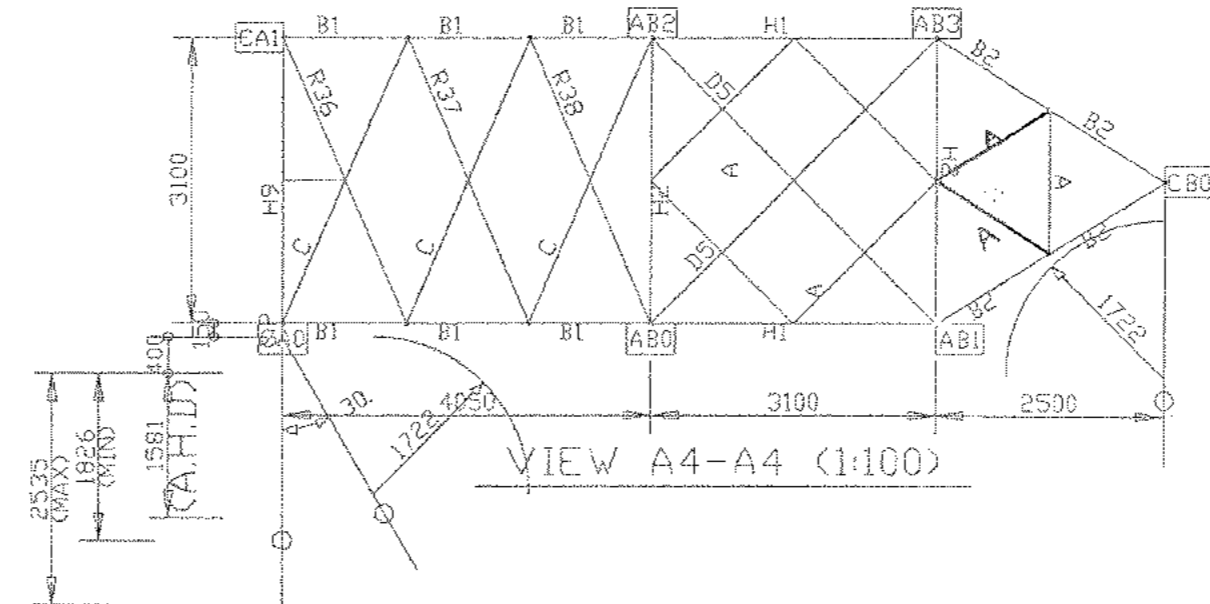
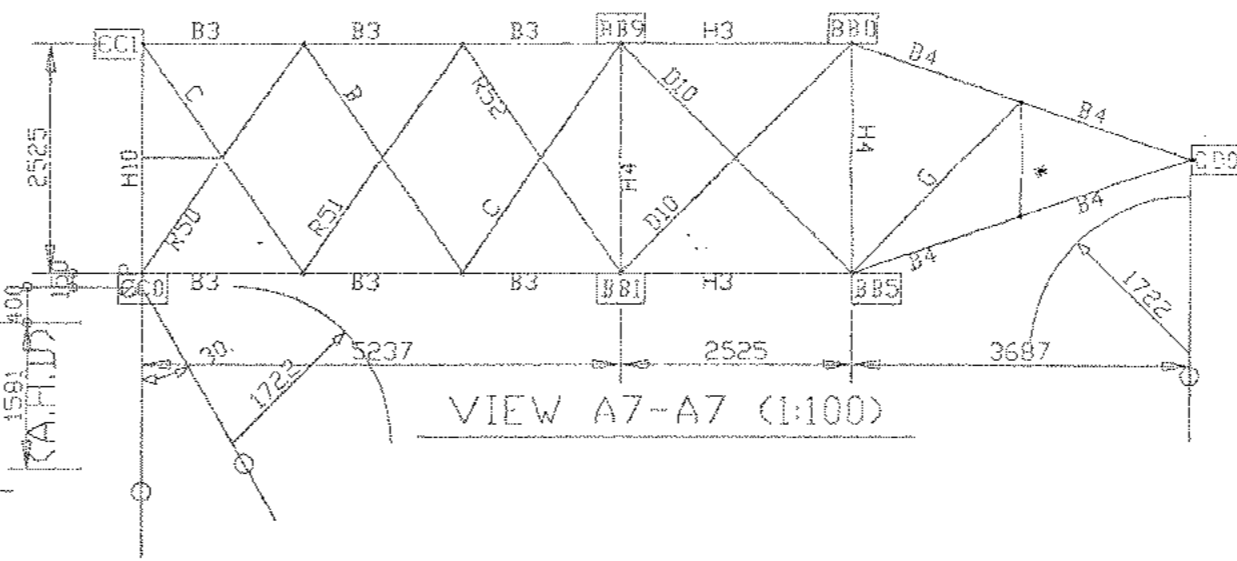
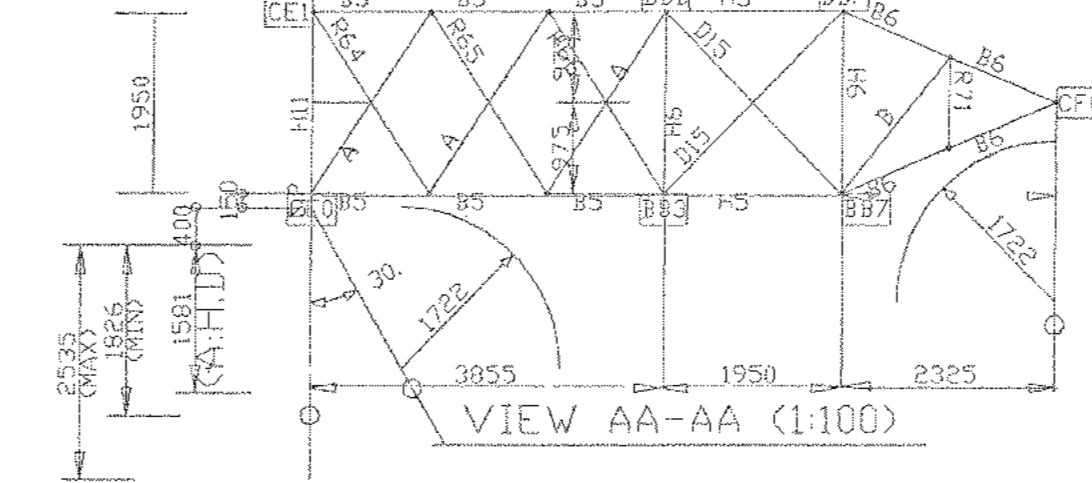

VIEW A3-A3 (1:100)

VIEW A2-A2 (1:100)

VIEW A1-A1 (1:100)

VIEW AC-AC (1:100)

VIEW A9-A9 (1:100)

VIEW A6-A6 (1:100)

GROUP NO.	SECTION	BOLTS NO	BOLT DIA
A. LEG MEMBERS:			
M1	HT L 120 X 120 X 10	8	12
M2	HT L 120 X 120 X 10	8	12
M3	MS L 120 X 120 X 10	8	12
M4	HT L 120 X 120 X 10	8	12
M5	HT L 90 X 90 X 7	4	8
M6	HT L 90 X 90 X 7	4	8
M7	HT L 90 X 90 X 7	4	8
M8	HT L 130 X 130 X 10	8	12
LATTICES/BRACINGS			
D1B/D19	MS L 75 X 75 X 5	3	5
D2	MS L 70 X 70 X 5	3	5
D3	MS L 75 X 75 X 6	3	5
D4	MS L 75 X 75 X 6	3	5
D5	MS L 65 X 65 X 5	3	5
D7	HT L 65 X 65 X 5	3	5
DB	HT L 80 X 80 X 5	3	5
D9	HT L 80 X 80 X 5	3	5
D10	MS L 75 X 75 X 5	3	5
D11	MS L 75 X 75 X 5	3	5
D12	MS L 70 X 70 X 5	3	5
D13	MS L 70 X 70 X 5	3	5
D14	MS L 70 X 70 X 5	3	5
D15	MS L 50 X 50 X 5	3	5
D16	MS L 50 X 50 X 5	3	5
D17	MS L 45 X 45 X 4	2	5
HORIZONTAL			
R1	MS L 70 X 70 X 5	2	5
R2	MS L 70 X 70 X 5	2	5
R3	MS L 75 X 75 X 6	4	5
R4	MS L 65 X 65 X 5	3	5
R5	MS L 65 X 65 X 5	3	5
R6	MS L 55 X 55 X 4	2	5
R7	MS L 55 X 55 X 4	2	5
R8	MS L 45 X 45 X 4	2	5
R9	MS L 75 X 75 X 6	3	5
R10	MS L 75 X 75 X 6	3	5
R11	MS L 75 X 75 X 6	3	5
MAIN ARM			
B1	HT L 75 X 75 X 5	4	5
B2	MS L 50 X 50 X 6	4	5
B3	MS L 50 X 50 X 6	4	5
B4	HT L 90 X 90 X 6	4	5
B5	HT L 75 X 75 X 5	4	5
B6	MS L 60 X 60 X 5	3	5
ARM TOPS			
T1	HT L 60 X 60 X 5	3	5
T2	MS L 65 X 65 X 4	3	5
T3	HT L 65 X 65 X 4	3	5
T4	MS L 65 X 65 X 5	3	5
T5	HT L 65 X 65 X 5	3	5
T6	MS L 60 X 60 X 4	3	5
PEAK MEMBERS			
P1	HT L 65 X 65 X 5	4	5

LEGEND

- L - SINGLE ANGLE
- SS - SINGLE SHEAR

REDUNDANTS

SEC MKD.	SECTION	REMARKS
A	MS L 50 X 50 X 4	
B	MS L 55 X 55 X 4	
C	MS L 60 X 60 X 4	
D	HT L 60 X 60 X 4	
F	MS L 65 X 65 X 4	
G	MS L 60 X 60 X 5	
H	HT L 60 X 60 X 5	
I	MS L 65 X 65 X 5	
J	HT L 65 X 65 X 5	
K	MS L 70 X 70 X 5	
L	HT L 70 X 70 X 5	
M	MS L 75 X 75 X 5	
N	HT L 75 X 75 X 5	
O	MS L 80 X 80 X 6	
P	HT L 80 X 80 X 6	
Q	MS L 90 X 90 X 6	
R	HT L 90 X 90 X 6	
S	MS L 100 X 100 X 6	
T	MS L 100 X 100 X 6	
UNNOTED SEC	MS L 45 X 30 X 4	

- NOTES:
- ALL DIMENSIONS ARE IN MM.
 - HT INDICATES HIGH TENSILE STEEL AS PER IS 2062 GR E350
 - MS INDICATES MILD STEEL AS PER IS 2062 GR E-250
 - ALL BOLTS ARE 16 MM DIAMETER OF GRADE 5.6 UNLESS OTHER WISE SPECIFIED
 - CONNECTED DRAWINGS: CCENGGTLCCENGGTL152411PP001 SHEET 2 OF 2.
 - CONNECTION OF SINGLE REDUNDANT TO LEG MEMBER UPTD CROSS ARM LEVEL SHALL BE DONE WITH MIN. TWO BOLTS.
 - WHEREVER SECTION SIZE/TYPE OF STEEL(MS/HT) ARE DIFFERENT FOR TRANS & LONG LATTICES, INTERCHANGEABILITY SHALL BE AVOIDED BY ADOPTING DIFFERENT DETAILINGS

POWER GRID CORPORATION OF INDIA LTD. - New Delhi.

SPECN. NO.	132 KV D/C LINE
DESCRIPTION	TOWER TYPE : DD WIND ZONE : 5 (50 m/s) WITH ACSR PANTHER CONDUCTOR
SCALE	AS SHOWN
DESIGN	AS PER IS 2062 GR E-250
CHECKED	AS PER IS 2062 GR E-250
REVIEWER	AS PER IS 2062 GR E-250
DRG. NO.	CCENGGTL152411P001
REV. 5TH	

ANNEXURE - 1
LIST OF PROTECTED AREAS

Sl. No.	Name of the Wildlife Sanctuary/National Park	Area in Sq Km	Location/ District	Important Flora and Fauna found
1.	Sepahijala Wildlife Sanctuary	18.54	Sepahijala	Birds and Primates, Migratory Birds in the winter, Spectacled Monkey.
2.	Gomati Wildlife Sanctuary	389.54	Dhalai, Gomati	Elephant, Sambar, Barking Deer, Wild Goats, Serrow etc.
3.	Trishna Wildlife Sanctuary	194.71	South Tripura	Birds and Primates, Bison, Leopard, Barking Deer, Wild Dog, Capped Langur, Spectacled Monkey, Slow Lorries, etc.
4.	Rowa Wildlife Sanctuary	0.86	North Tripura	Many species of Birds and Primates
5.	Bison (Rajbari) National Park	31.63	South Tripura	Bisons and many species of Birds
6.	Clouded Leopard National Park	5.08	West Tripura	Clouded Leopard, Spectacled Langur and many Birds

ANNEXURE – 2

LOCATION DETAILS OF SUBSTATION



BAGAFSA SUBSTATION



BELONIA SUBSTATION



SABROOM SUBSTATION



SATCHAND SUBSTATION

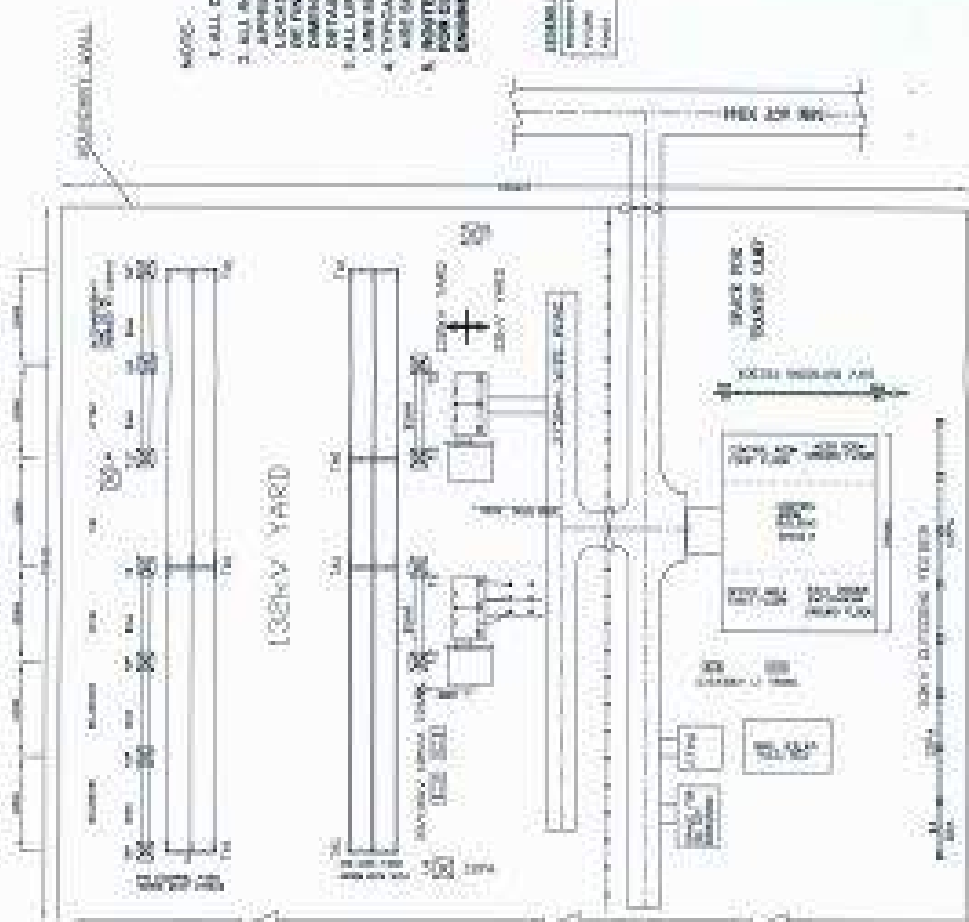

EXISTING WALL

TO EXISTING 66/11KV EXISTING SWITCHYARD

TO EXISTING CONTROL ROOM AND 66KV BUS

- NOTES:
1. ALL DIMENSIONS ARE IN MM.
 2. ALL ROAD PLOT CORNER BUILDINGS (M, TYPICAL) APPROACH ROAD, MAX. TRACK PITCH AND LR LOCATIONS ARE SHOWN TENTATIVELY ONLY AND SHALL BE FINAL 90 DAYS AFTER VARIATION ACTUAL. PLOT DIMENSIONS INCLUDING LINE CORRECTIONS DURING DETAILED ENGINEERING.
 3. ALL LINE CORRECTIONS SHALL BE AS PER ACTUAL LINE SPACING.
 4. TYPICAL ELECTRICAL LAYOUT PLAN & SECTION ARE SHOWN APPROXIMATELY.
 5. ROUTE OF 132KV BUNDLED CABLE TRUNKS ARE NOT SHOWN FOR CLARITY. THE SAME SHALL BE PROVIDED DURING DETAIL ENGINEERING.



PROJECT INFORMATION	
PROJECT NAME	132KV/13.8KV TRANSFORMER
CLIENT	INDIA RAILWAYS
DATE	15/08/2023
SCALE	AS SHOWN
DESIGNER	INDIA RAILWAYS
CHECKER	INDIA RAILWAYS
APPROVED BY	INDIA RAILWAYS

DESIGNED BY	INDIA RAILWAYS
CHECKED BY	INDIA RAILWAYS
APPROVED BY	INDIA RAILWAYS
DATE	15/08/2023
SCALE	AS SHOWN
PROJECT NAME	132KV/13.8KV TRANSFORMER
CLIENT	INDIA RAILWAYS



VIEW OF BAGAFA 66/33/11 KV EXISTING SUBSTATION

Site Plan & Actual Photograph of Proposed 132/33 KV Substation at Bagafa

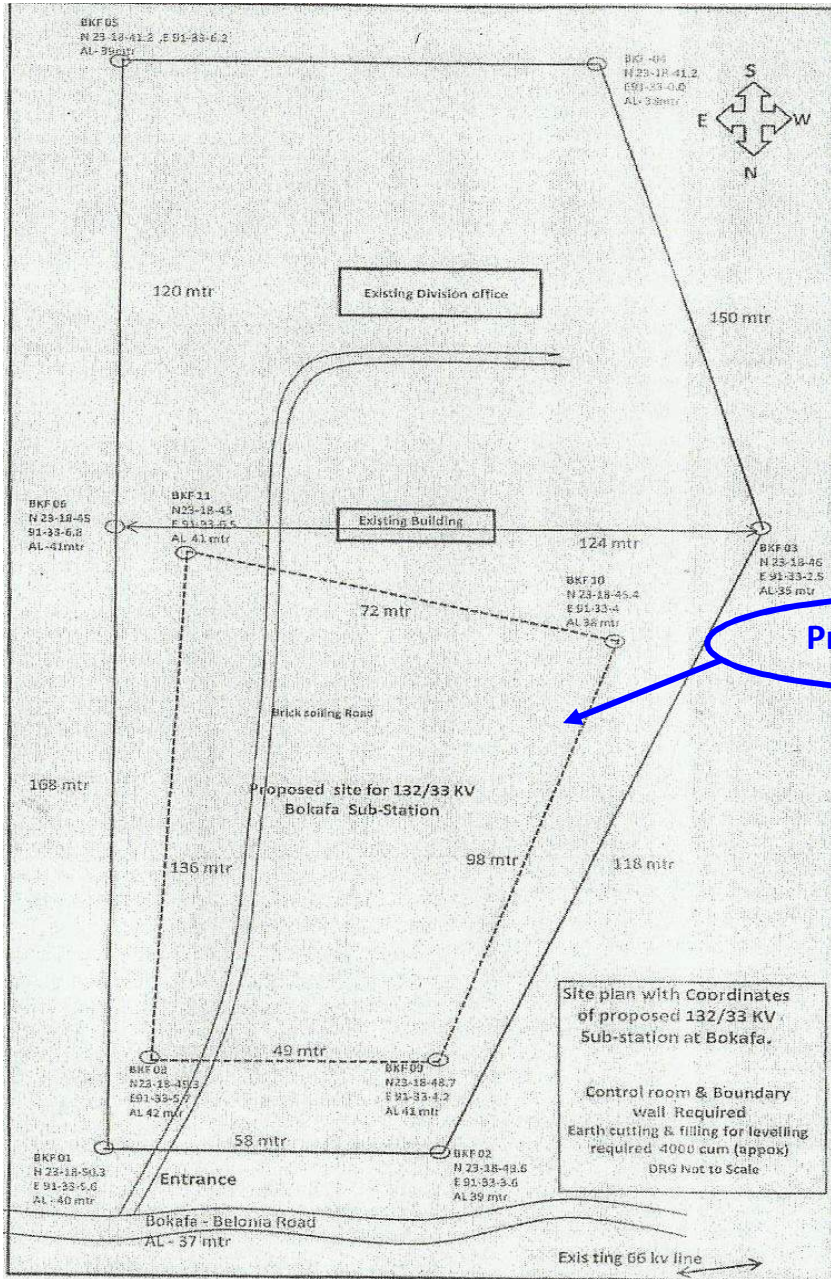

Proposed Site



Land for proposed substation

03 03 2015

VIEW OF BELONIA 66/33/11 KV EXISTING SUBSTATION

Site Plan & Actual Photograph of Proposed 132/33 KV Substation at Belonia



Proposed Site



Land for proposed substation

VIEW OF SABROOM 66 KV EXISTING SUBSTATION

Site Plan & Actual Photograph of Proposed 132/33 KV Substation at Sabroom

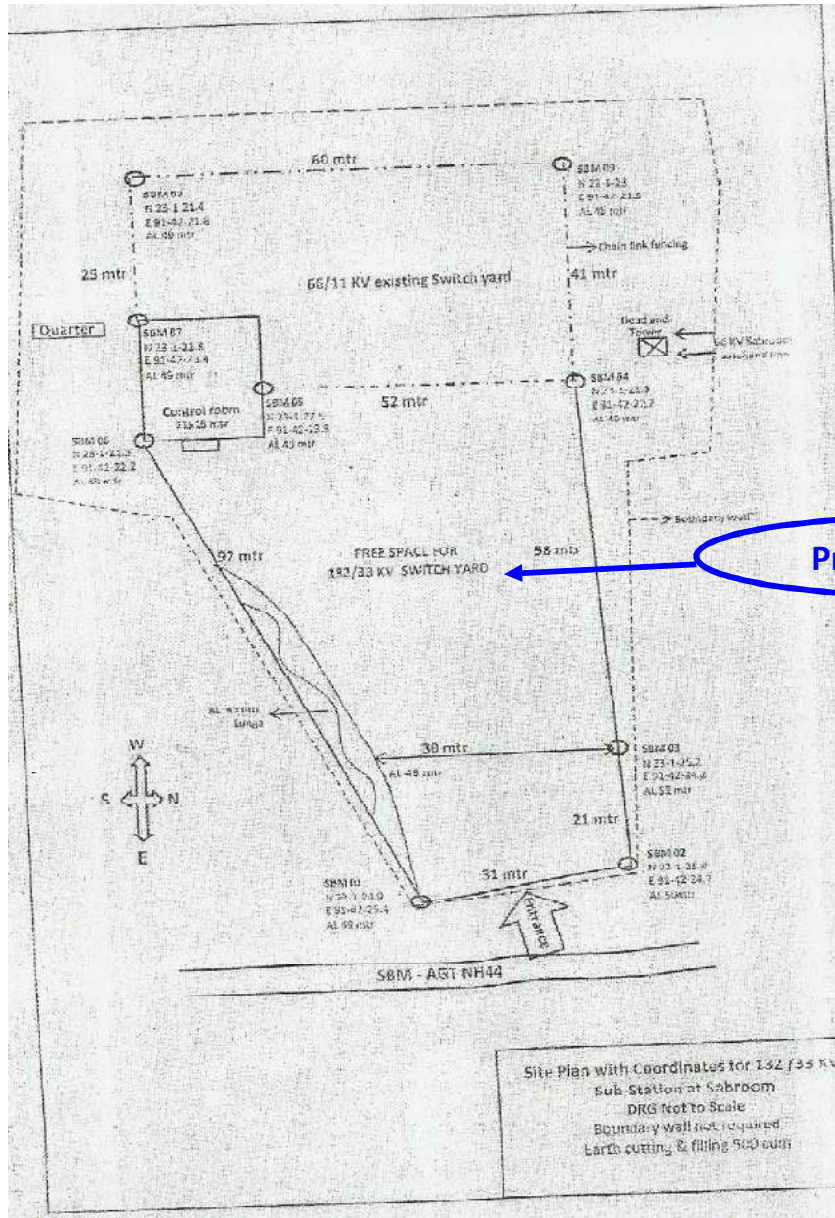

Proposed Site



VIEW OF SATCHAND 66 KV EXISTING SUBSTATION

Site Plan & Actual Photograph of Proposed 132/33 KV Substation at Satchand

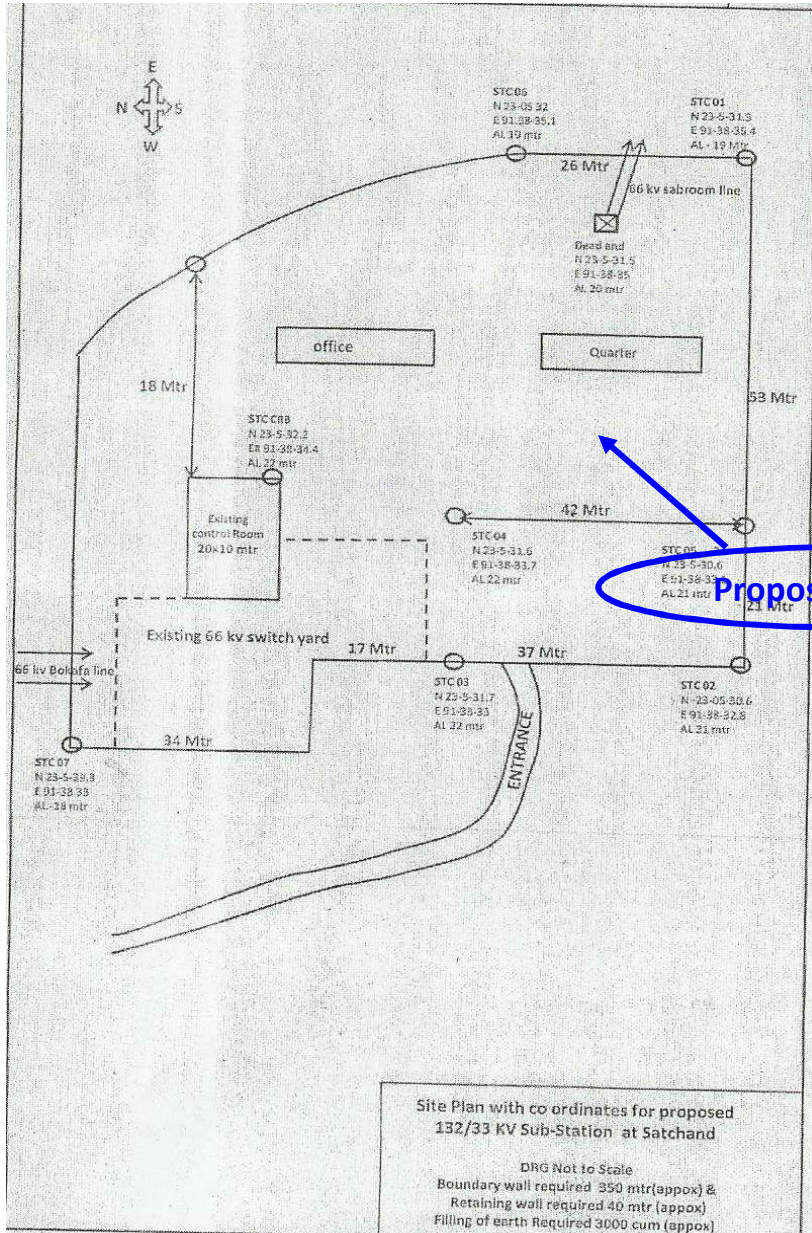

ANNEXURE – 3

***TREE, CROP AND TOWER BASE
COMPENSATION PROCEDURE***

TREE / CROP/ TOWER FOOTING COMPENSATION PROCESS (OTHER THAN FOREST LAND COMPENSATION)

As per the provisions of Electricity Act, 2003 and Indian Telegraph Act 1885, land for tower and right of way is not acquired and agricultural activities are allowed to continue. However, the acts also stipulate that licensee shall pay full compensation to all interested for any damages sustained during the execution of said work. Accordingly, TSECL pays compensation to land owners towards damages if any during implementation of transmission project as well as during operation and maintenance phase.

TSECL follows the principle of avoidance, minimization and mitigation in the construction of line in agricultural field having crop due to inherent flexibility in phasing the construction activity and tries to defer construction in cropped area to facilitate crop harvesting. However, if it is unavoidable and is likely to affect project schedule, compensation is given at market rate for standing crops. All efforts are also taken to minimize the crop damage to the extent possible in such cases.

As regards trees coming in the Right of Way (RoW) following procedure is adopted for enumeration: All the trees which are coming within the clearance belt of ROW on either side of the center line are identified and marked/numbered from one AP (Affected Person) to the other and documented. Type, Girth (Measured 1 m. above ground level), approximate height of the tree is also noted for each tree. Trees belonging to Govt., Forest, Highways and other local bodies may be separately noted down or timely follow up with the concerned authorities for inspection and removal. Cashew, Guava, Lemon and other hybrid trees which are not of tall growing nature are not marked for cutting since these trees can be crossed using standard tower extensions if required.

TSECL also pay compensation to affected land owners for utilization of their land for tower footing.

A notice under Electricity Act, 2003/ Indian Telegraph Act, 1885 is served to the landowners informing that the proposed transmission line is being routed through the property of the individual concerned. The notice shall contain the particulars of the land, ownership details and the details of the trees/crops/land inevitably likely to be damaged during the course of the construction of the proposed transmission line and acknowledgement received from land owners. A copy of said notice is further issued to the Revenue Officer/SDM, who has been authorized by the Tripura Govt. for the purpose of assessment/valuation and disbursement of compensation to the affected parties.

The revenue officer shall further issue a notice of intimation to the concerned land owner and inspect the site to verify the documents related to the proof of ownership and a detailed Mouja list is prepared for the identified trees/ crops/ land for tower footing inevitably damaged during the course of the construction. For assessing the true value of timber yielding trees

help of forest officials is taken and for fruit bearing trees help of Horticulture department is taken.

The Mouja list shall contain the land owner details including extent land area utilization for tower footing, type of tree/crop, its present age, variety, yielding pattern etc. and the same is prepared at site in the presence of the land owner. These Mouja lists are further compiled and a random verification is conducted by the concerned DC or his authorized representative in order to ascertain the assessment carried out by the revenue office is genuine and correct. After this process the District Collector/ a tree cutting permit to TSECL to enable removal / damage to the standing tree/crop identified in the line corridor. Similarly on the basis of enquiry report received from concerned Tehsildar, SDM issue land valuation certificate to TSECL for payment of compensation to land owner.

Once the tree/crop is removed / damaged, TSECL shall issue a tree cutting/crop damaged notice to the land owner with a copy to the Revenue Officer to process the compensation payment. Based on the above the compensation payment is generated by means of a computerized programme developed by the National Informatics Center exclusively for this purpose. The detailed Valuation statement thus generated using this programme is verified at various levels and approval of payment of compensation is accorded by the concerned District Collectors.

On approval of compensation, the revenue officer shall further intimate the amount payable to the different landowners and TSECL arranges the payment by way of Demand Draft to the affected parties. The payment is further disbursed at the local village office after due verification of the documents in presence of other witnesses.

TREE / CROP/TOWER FOOTING COMPENSATION PROCESS

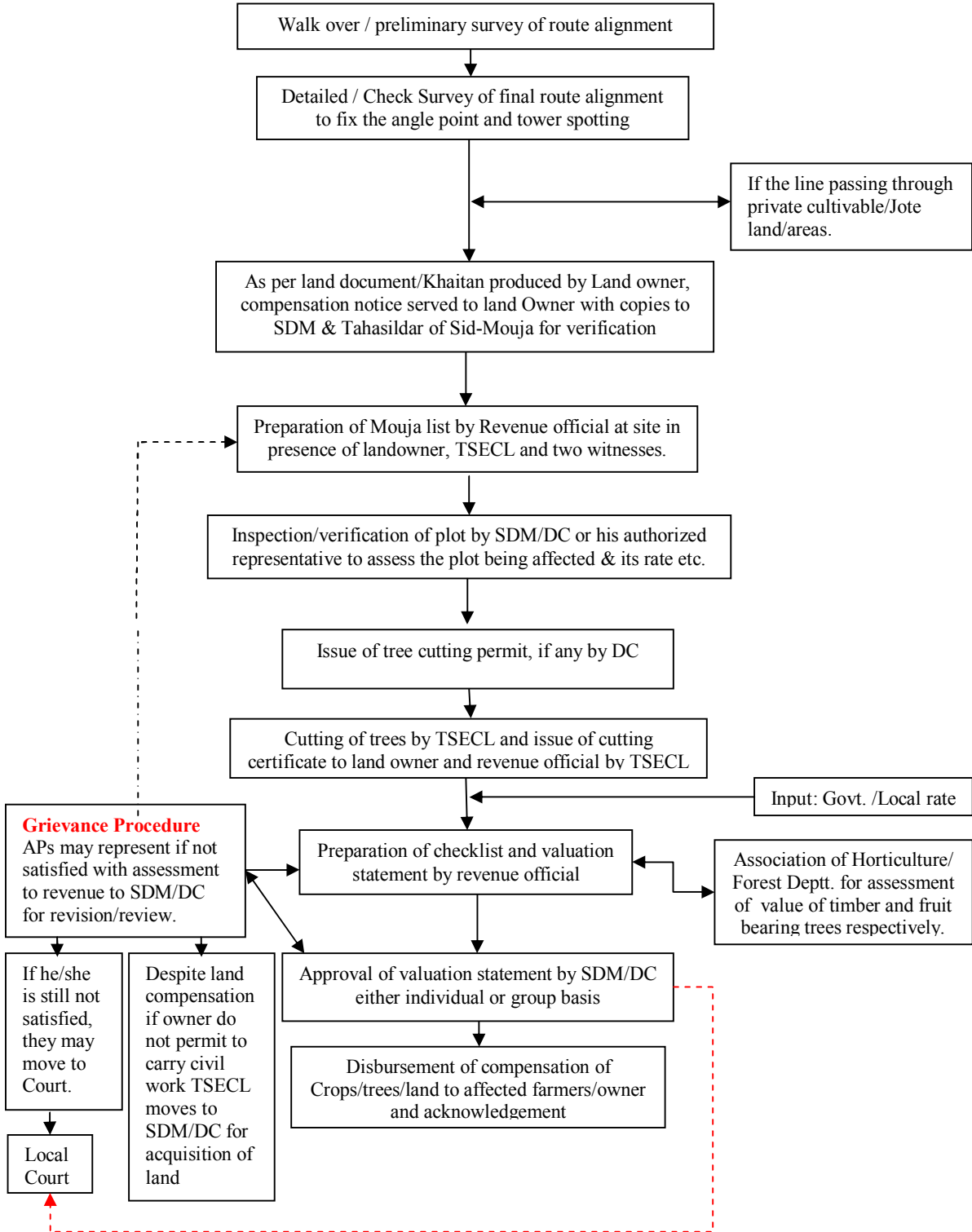

ANNEXURE – 4

***CONSERVATION STATUS OF IMPORTANT
FAUNA OF TRISHNA WILDLIFE SANCTUARY***

Conservation Status of Important Fauna of Trishna Wildlife Sanctuary

Trishna Wild life Sanctuary is located in South district of Tripura, having a total area of 194.71 km². The sanctuary consists of dense primary forest (62%) dominated by *Shorea robusta*, *Dipterocarpus turbinatus*, and *Terminalia belliraca*, degraded forest (18%) dominated by *Toona ciliate*, *Albizia procera* and busy forest (20%).

The main Mammalian species found in Trishna Wildlife Sanctuary are Asian Bison (*Bos gorus*), Wild Boar (*Sus scrofa*), Spectacle Monkey (*Trachypithecus phayrie*), Phayre's Leaf Monkey (*Presbytis phayrei*), Capped Langur (*Trachypithecus pileatus*), Slow loris (*Nycticebus coucang*), Wild Cat (*Felis chaus*), King Cobra (*Ophiophagus hannah*), Hoolock Gibbon (*Hylobates hoolock*), Leopard (*Panthera pardus*), Marbled Cat (*Felis marmorata*), Leopard Cat (*Felis bengalensis*), Golden Cat (*Felis temmincki*), Common Otter (*Lutra lutra*), Indian Elephant (*Elephas maximus*).

Common bird found in Trishna include species like Pheasant tailed Jacana (*Hydrophasianus chirurgus*), Red Jungle Fowl (*Gallus gallus*), White Breasted Kingfisher (*Halcyon smyrnensis*), Indian Black drongo (*Dicrurus macrocercus*), Tailer bird (*Orthotomus sutorius*), Jungle Myna (*Acridotheres fuscus*), Parrot (*Psittacine sp*), Eagle (*Hieraetus Spilogaster*), Hornbill (*Bucerotidae sp*), Dove (*Columbidae sp*).

Trishna Wild life Sanctuary is also home to about 59 butterfly species belonging to 48 genera and 5 families. These included species like *Papilio polytes*, *Papilio demoleus*, *Castalius rosimon*, *Eurema hecabe*, *Letha europa*, *Cepora nerissa*, *Castalius rosimon*, *Narathura selta*, *Baoris farri*, *Troides helena* and *Labadea martha*.

CONSERVATION STATUS OF IMPORTANT FAUNA OF SANCTUARY

Sr. No.	Common Name	Scientific Name	IUCN Category
A. Mammals/Reptiles			
1	Asian Bison	<i>Bos gorus</i>	VU
2	Wild Boar	<i>Sus scrofa</i>	LC
3	Spectacle Monkey		NT
4	Phayre's Leaf Monkey	<i>Trachypithecus phayrie</i>	EN
5	Capped Langur	<i>Trachypithecus pileatus</i>	VU
6	Slow loris	<i>Nycticebus coucang</i>	VU
7	Wild Cat	<i>Felis chaus</i>	LC
8	King Cobra	<i>Ophiophagus hannah</i>	VU
9	Hoolock Gibbon	<i>Hylobates hoolock</i>	EN
10	Leopard	<i>Panthera pardus</i>	NT
11	Marbled Cat	<i>Pardofelis marmorata</i>	VU
12	Leopard Cat	<i>Prionailurus bengalensis</i>	LC
13	Golden Cat	<i>Pardofelis temmincki</i>	NT

14	Common Otter	<i>Lutra lutra</i>	NT
15	Indian Elephant	<i>Elephas maximus</i>	EN
B. Birds			
17	Pheasant tailed Jacana	<i>Hydrophasianus chirurgus</i>	LC
18	Red Jungle Fowl	<i>Gallus gallus</i>	LC
19	White Breasted Kingfisher	<i>Halcyon smyrnensis</i>	LC
20	Indian Black drongo	<i>Dicrurus macrocercus</i>	LC
21	Tailer bird	<i>Orthotomus sutorius</i>	LC
22	Jungle Myna	<i>Acridotheres fuscus</i>	LC
23	Parrot	<i>Psittacine sp</i>	LC
24	Eagle	<i>Hieraatus Spilogaster</i>	LC
25	Hornbil	<i>Bucerotidae sp</i>	LC
26	Dove	<i>Spilopelia chinensis</i>	LC
C. Butterflies			
27		<i>Papilio polytes</i>	LC
28		<i>Papilio demoleus</i>	LC
29		<i>Castalius rosimon</i>	NA
30		<i>Eurema hecabe</i>	NA
31		<i>Letha europa</i>	NA
32		<i>Cepora nerissa</i>	NA
33		<i>Castalius rosimon</i>	NA
34		<i>Narathura selta</i>	NA
35		<i>Baoris farri</i>	NA
36		<i>Troides helena</i>	NA
37		<i>Labadea martha</i>	NA

IUCN Red list Categories:

EX – Extinct

EW – Extinct in Wild

CR – Critically Endangered

EN – Endangered

VU – Vulnerable

NT – Near Threatened

LC – Least Concern

ANNEXURE – 5
SAFETY PLAN

13. FORM OF SAFETY PLAN TO BE SUBMITTED BY THE CONTRACTOR WITHIN SIXTY DAYS OF AWARD OF CONTRACT

[TO BE EXECUTED ON A NON JUDICIAL STAMP PAPER WORTH RS. TWENTY ONLY]

SAFETY PLAN

THIS SAFETY PLAN is made this day of 20..... by a Company registered under the Companies Act, 1956/Partnership firm/proprietary concern having its Registered Office at[*to be modified suitably for JV Contractor*] (hereinafter called as 'Contractor' which expression shall include its successors and permitted assigns) for approval of(*insert name of the Employer*)....., a company incorporated under the Companies Act, 1956 having its Registered Office at(*insert registered address of the Employer*)..... for its Contract for(*insert package name, project name alongwith Specification number of the Contract*).....

WHEREAS(*abbreviated name of the Employer*)..... has awarded to the Contractor the aforesaid Contract vide its Notification of Award/Contract No. datedand Amendment No. (applicable when amendments have been issued) (hereinafter called the "Contract") in terms of which the Contractor is required to submit 'Safety Plan' along with certain documents to the Engineer In-Charge/Project Manager of the Employer within Sixty (60) days of Notification of Award for its approval.

NOW THEREFORE, the Contractor undertakes to execute the Contract as per the safety plan as follows:

1. THAT the Contractor shall execute the works as per provisions of Bidding Documents including those in regard to Safety Precautions / provisions as per statutory requirements.
2. THAT the Contractor shall execute the works in a well planned manner from the commencement of Contract as per agreed mile stones of work completion schedule so that planning and execution of construction works goes smoothly and consistently through out the contract duration without handling pressure in last quarter of the financial year/last months of the Contract and the shall be finalized in association with EMPLOYER Engineer In-charge/Project Manager from time to time as required.
3. THAT the Contractor has prepared the safe work procedure for each activity i.e. foundation works including civil works, erection, stringing (as applicable), testing & commissioning, disposal of materials at site / store etc. to be executed at site, which is enclosed at **Annexure – 1A (SP)** for acceptance and approval of Engineer In-charge/Project Manager. The Contractor shall ensure that on approval of the same from Engineer In-charge/Project Manager , the approved copies will be circulated to Employer's personnel at site [Supervisor(s)/Executive(s)] and Contractor's personnel at site [Gang leader, supervisor(s) etc.] in their local language / language understood by gang.

THAT the Contractor has prepared minimum manpower deployment plan, activity wise as stated above, which is enclosed at **Annexure – 1B (SP)** for approval of Engineer In-charge/Project Manager.

4. THAT the Contractor shall ensure while executing works that they will deploy minimum 25% of their own experienced work force who are on the permanent roll of the company and balance 75% can be a suitable mix with the hired gangs / local workers / casual workers if required. The above balance 75% work force should be provided with at least 10 days training by the construction agencies at sites and shall be issued with a certificate. No worker shall be engaged without a valid certificate. Hired gang workers shall also follow safe working procedures and safety norms as is being followed by company's workmen. It should also be ensured by the contractor that certified fitters who are climbing towers / doing stringing operations can be easily identifiable with a system like issue of Badge / Identification cards (ID cards) etc. Colour identification batches should be worn by the workers. Contractor has to ensure that inexperienced workers / unskilled workers should not be deployed for skilled job.
5. THAT the Contractor's Gang leader / Supervisor / Senior most member available at every construction site shall brief to each worker daily before start of work about safety requirement and warn about imminent dangers and precautions to be taken against the imminent dangers (Daily Safety Drill). This is to be ensured without fail by Contractor and maintain record of each gang about daily safety instructions issued to workers and put up to EMPLOYER site In-charge for his review and record.
6. THAT the Contractor shall ensure that working Gangs at site should not be left at the discretion of their Gang Leaders who are generally hired and having little knowledge about safety. Gang leader should be experienced and well versed with the safe working procedures applicable for transmission line/ Sub Station works. In case gang is having Gang leader not on permanent roll of the company then additional Supervisor from company's own roll having thorough knowledge about the works would be deployed so as to percolate safety instructions up to the grass root level in healthy spirits. Contractor has to ensure close supervision while executing critical locations of transmission lines / sub stations and ensures that all safety instructions are in place and are being followed.
7. THAT the Contractor shall maintain in healthy and working condition all kind of Equipments / Machineries / Lifting tools / Lifting tackles / Lifting gears / All kind of Ropes including wire ropes / Polypropylene ropes etc. used for Lifting purpose during execution of the project and get them periodically examined and load tested for safe working load in accordance with relevant provisions and requirement of Building & other construction workers Regulation of Employment and Conditions of Services Act and Central Rule 1998, Factories Act 1948, Indian Electricity Act 2003 before start of the project. A register of such examinations and tests shall be properly maintained by the contractor and will be promptly produced as and when desired by the Engineer In-charge/Project Manager or by the person authorised by him. The Contractor has to ensure to give special attention on the formation / condition of eye splices of wire rope slings as per requirement of IS 2762 Specification for wire rope slings and sling legs.

THAT the Contractor has prepared a list of all Lifting machines, lifting Tools / Lifting Tackles / Lifting Gears etc. / All types of ropes and Slings which are subject to safe working load is enclosed at **Annexure – 2 (SP)** for review and approval of Engineer In-charge/Project Manager.

8. THAT the Contractor has to procure sufficient quantity of Personal Protective Equipment (PPE) conforming to Indian / International standards and provide these equipment to every workman at site as per need and to the satisfaction of Engineer-in-charge/Project Manager of EMPLOYER. The Contractor's Site Supervisor/ Project Manager has to ensure that all workmen must use Personal Protective Equipment at site. The Contractor shall also ensure that Industrial Safety helmets are being used by all workmen at site irrespective of their working (at height or on ground). The Contractor shall further ensure use of safety shoes by all ground level workers and canvas shoes for all workers working at height, Rubber Gum Boots for workers working in rainy season and concreting job, Use of Twin Lanyard Full body Safety Harness with attachment of light weight such as aluminium alloy etc. and having features of automatic locking arrangement of snap hook, by all workers working at height for more than three meters and also for horizontal movement on tower shall be ensured by contractor. The Contractor shall not use ordinary half body safety harness at site. The Contractor has to ensure use of Retractable type fall arrestors by workers for ascending / descending on suspension insulator string and other similar works etc., Use of Mobile fall arrestor for ascending / descending from tower by all workers. The contractor has to provide cotton / leather hand gloves as per requirement, Electrical Resistance Hand gloves for operating electrical installations / switches, Face shield for protecting eyes while doing welding works and Dust masks to workers as per requirement. The Contractor will have to take action against the workers not using Personal Protective Equipment at site and those workers shall be asked to rest for that day and also their Salary be deducted for that day. EMPLOYER may issue warning letter to Project Manager of contractor in violation of above norms.

THAT the Contractor shall prepare a detailed list of PPEs, activity wise, to commensurate with manpower deployed, which is enclosed at **Annexure – 3 (SP)** for review and approval of Engineer In-charge/Project Manager. It shall also be ensured that the sample of these equipment shall be got approved from EMPLOYER supervisory staff before being distributed to workers. The contractor shall submit relevant test certificates as per IS / International Standard as applicable to PPEs used during execution of work. All the PPE's to be distributed to the workers shall be checked by EMPLOYER supervisory staff before its usage.

The Contractor also agrees for addition / modification to the list of PPE, if any, as advised by Engineer In-Charge/Project Manager.

9. THAT the Contractor shall procure, if required sufficient quantity of Earthing Equipment / Earthing Devices complying with requirements of relevant IEC standards (Generally IECs standards for Earthing Equipments / Earthing Devices are – 855, 1230, 1235 etc.) and to the satisfaction of Engineer In-Charge/ Project Manager and contractor to ensures to maintained them in healthy condition.

THAT the Contractor has prepared / worked out minimum number of healthy Earthing Equipments with Earthing lead confirming to relevant IS / European standards per gang wise during stringing activity/as per requirement, which is enclosed herewith at **Annexure – 4 (SP)** for review and acceptance of Engineer In-Charge/ Project Manager prior to execution of work.

10. THAT the Contractor shall provide communication facilities i.e. Walky – Talkie / Mobile Phone, Display of Flags / whistles for easy communication among workers during Tower erection / stringing activity, as per requirement.
11. THAT the Contractor undertakes to deploy qualified safety personnel responsible for safety as per requirements of Employer/Statutory Authorities.

THAT the Contractor employing more than 250 workmen whether temporary, casual, probationer, regular or permanent or on contract, shall employ at least one full time officer exclusively as qualified safety officer having diploma in safety to supervise safety aspects of the equipment and workmen who will coordinate with Engineer In-charge /Project Manager/Safety Coordinator of the Employer. In case of work being carried out through sub contractors the sub – contractor's workmen / employees will also be considered as the contractor's employees / workmen for the above purpose. If the number of workers are less than 250 then one qualified safety officer is to be deployed for each contract. He will report directly to his head of organization and not the Project Manager of contractor He shall also not be assigned any other work except assigning the work of safety. The curriculum vitae of such person shall be got cleared from EMPLOYER Project Manager / Construction staff.

The name and address of such safety officers of contractor will be promptly informed in writing to Engineer In-charge with a copy to safety officer - In-charge before start of work or immediately after any change of the incumbent is made during the currency of the contract. The list is enclosed at **Annexure – 5A (SP)**.

THAT the Contractor has also prepared a list including details of Explosive Operator (if required), Safety officer / Safety supervisor / nominated person for safety for each erection / stringing gang, list of personnel trained in First Aid Techniques as well as copy of organisation structure of the Contractor in regard to safety. The list is enclosed at **Annexure – 5B (SP)**.

12. The Project Manager shall have the right at his sole discretion to stop the work, if in his opinion the work is being carried out in such a way that it may cause accidents and endanger the safety of the persons and/or property, and/or equipment. In such cases, the Contractor shall be informed in writing about the nature of hazards and possible injury/accident and he shall comply to remove shortcomings promptly. The Contractor after stopping the specific work can, if felt necessary, appeal against the order of stoppage of work to the Project Manager within 3 days of such stoppage of work and decision of the Project Manager in this respect shall be conclusive and binding on the Contractor.
13. THAT, if, any Employer's Engineer/ supervisor at site observes that the Contractor is failing to provide safe working environment at site as per agreed Safety Plan / EMPLOYER Safety Rule/ Safety Instructions / Statutory safety requirement and creates hazardous conditions at site and there is possibility of an accident to workmen or workmen of the other contractor or public or the work is being carried out in an un safe manner or he continues to work even after being instructed to stop the work by Engineer / Supervisor at site / RHQ / Corp. Centre, the Contractor shall be bound to pay a penalty of Rs. 10,000/ - per incident per day till the instructions are complied and as certified by Engineer / Supervisor of Employer at site. The work will remain suspended and no activity will take

place without compliance and obtaining clearance / certification of the Site Engineer / Supervisor of the Employer to start the work.

14. THAT, if the investigation committee of Employer observes any accident or the Engineer In-charge/Project Manager of the Employer based on the report of the Engineer/Supervisor of the Employer at site observes any failure on the Contractor's part to comply with safety requirement / safety rules/ safety standards/ safety instruction as prescribed by the Employer or as prescribed under the applicable law for the safety of the equipment, plant and personnel and the Contractor does not take adequate steps to prevent hazardous conditions which may cause injury to its own Contractor's employees or employee of any other Contractors or Employer or any other person at site or adjacent thereto, or public involvement because of the Contractor's negligence of safety norms, the Contractor shall be liable to pay a compensation of Rs. 10,00,000/- (Rupees Ten Lakh only) per person affected causing death and Rs. 1,00,000/- (Rupees One Lakh only) per person for serious injuries / 25% or more permanent disability to the Employer for further disbursement to the deceased family/ Injured persons. The permanent disability has the same meaning as indicated in Workmen's Compensation Act 1923. The above stipulations is in addition to all other compensation payable to sufferer as per workmen compensation Act / Rules

THAT as per the Employer's instructions, the Contractor agrees that this amount shall be deducted from their running bill(s) immediately after the accident, That the Contractor understands that this amount shall be over and above the compensation amount liable to be paid as per the Workmen's Compensation Act /other statutory requirement/ provisions of the Bidding Documents.

15. THAT the Contractor shall submit Near-Miss-Accident report along with action plan for avoidance such incidence /accidents to Engineer – In-charge/ Project Manager. Contractor shall also submit Monthly Safety Activities report to Engineer – In-charge/ Project Manager and copy of the Monthly Safety Activities report also to be sent to Safety In-charge at RHQ of the Employer for his review record and instructions.
16. THAT the Contractor is submitting a copy of Safety Policy/ Safety Documents of its Company which is enclosed at **Annexure – 6 (SP)** and ensure that the safety Policy and safety documents are implemented in healthy spirit.
17. THAT the Contractor shall make available of First Aid Box [Contents of which shall be as per Building & other construction workers (Regulation of Employment and Conditions of Services Act and Central Rule 1998 / EMPLOYER Guidelines)] to the satisfaction of Engineer In-Charge/ Project Manager with each gang at site and not at camp and ensures that trained persons in First Aid Techniques with each gang before execution of work.
18. THAT the Contractor shall submit an 'Emergency Preparedness Plan' for different incidences i.e. Fall from height, Electrocution, Sun Stroke, Collapse of pit, Collapse of Tower, Snake bite, Fire in camp / Store, Flood, Storm, Earthquake, Militancy etc. while carrying out different activities under execution i.e. foundation works including civil works, erection, stringing (as applicable), testing & commissioning, disposal of materials at site / store etc. which is enclosed at **Annexure – 7 (SP)** for approval of the Engineer In-Charge/ Project Manager before start of work.

19. THAT the Contractor shall organise Safety Training Programs on Safety, Health and Environment and for safe execution of different activities of works i.e. foundation works including civil works, erection, stringing (as applicable), testing & commissioning, disposal of materials at site / store etc. for their own employees including sub contractor workers on regular basis.

The Contractor, therefore, submits copy of the module of training program, enclosed at **Annexure – 9 (SP)**, to Engineer In-charge/Project Manager for its acceptance and approval and records maintained.

20. THAT the Contractor shall conduct safety audit, as per Safety Audit Check Lists enclosed at **Annexure – 8 (SP)**, by his Safety Officer(s) every month during construction of Transmission Lines / Sub Stations / any other work and copy of the safety audit report will be forwarded to the Employer's Engineer In-charge / Site In-charge/Project Manager for his comments and feedback. During safety audit, healthiness of all Personal Protective Equipments (PPEs) shall be checked individually by safety officer of contractor and issue a certificate of its healthiness or rejection of faulty PPEs and contractor has to ensure that all faulty PPEs and all faulty lifting tools and tackles should be destroyed in the presence of EMPLOYER construction staff. Contractor has to ensure that each gang be safety audited at least once in two months. During safety audit by the contractor, Safety officer's feedback from EMPLOYER concerned shall be taken and recorded. The Employer's site officials shall also conduct safety audit at their own from time to time when construction activities are under progress. Apart from above, the Employer may also conduct surveillance safety audits. The Employer may take action against the person / persons as deemed fit under various statutory acts/provisions under the Contract for any violation of safety norms / safety standards.
21. THAT the Contractor shall develop and display Safety Posters of construction activity at site and also at camp where workers are generally residing.
22. THAT the Contractor shall ensure to provide potable and safe drinking water for workers at site / at camp.
23. THAT the Contractor shall do health check up of all workers from competent agencies and reports will be submitted to Engineer In-Charge within fifteen (15) days of health check up of workers as per statutory requirement.
24. THAT the Contractor shall submit information along with documentary evidences in regard to compliance to various statutory requirements as applicable which are enclosed at **Annexure – 10A (SP)**.

The Contractor shall also submit details of Insurance Policies taken by the Contractor for insurance coverage against accident for all employees are enclosed at **Annexure – 10B (SP)**.

25. THAT a check-list in respect of aforesaid enclosures along with the Contractor's remarks, wherever required, is attached as **Annexure – Check List** herewith.

THE CONTRACTOR shall incorporate modifications/changes in this 'Safety Plan' necessitated on the basis of review/comments of the Engineer In-Charge/Project Manager within fourteen (14) days of receipt of review/comments and on final approval of the Engineer In-Charge/Project Manager of this 'Safety Plan', the Contractor shall execute the works under the Contract as per approved 'Safety Plan'. Further, the Contractor has also noted that the first progressive payment towards Services Contract shall be made on submission of 'Safety Plan' along with all requisite documents and approval of the same by the Engineer In-Charge/Project Manager.

IN WITNESS WHEREOF, the Contractor has hereunto set its hand through its authorised representative under the common seal of the Company, the day, month and year first above mentioned.

For and on behalf of

M/s.....

WITNESS

1. Signature.....

Signature.....

Name.....

Name.....

Address.....

Address.....

2. Signature.....

Authorised representative

Name.....

(Common Seal)

Address.....

(In case of Company)

Note:

All the annexure referred to in this "Safety Plan" are required to be enclosed by the contractor as per the attached "Check List "

1. Safety Plan is to be executed by the authorised person and (i) in case of contracting Company under common seal of the Company or (ii) having the power of attorney issued under common seal of the company with authority to execute such contract documents etc., (iii) In case of (ii), the original Power of Attorney if it is specifically for this Contract or a Photostat copy of the Power of Attorney if it is General Power of Attorney and such documents should be attached to this Safety Plan.
2. For all safety monitoring/ documentation, Engineer In-charge / Regional In-charge of safety at RHQ will be the nodal Officers for communication.

CHECK LIST FOR SEFETY PLAN

S. N.	Details of Enclosure	Status of Submission of information/ documents	Remarks
1.	<p>Annexure – 1A (SP)</p> <p>Safe work procedure for each activity i.e. foundation works including civil works, erection, stringing (as applicable), testing & commissioning, disposal of materials at site / store etc. to be executed at site.</p>	Yes/No	
2.	<p>Annexure – 1B (SP)</p> <p>Manpower deployment plan, activity wise foundation works including civil works, erection, stringing (as applicable), testing & commissioning, disposal of materials at site / store etc.</p>	Yes/No	
3.	<p>Annexure – 2 (SP)</p> <p>List of Lifting Machines i.e. Crane, Hoist, Triffor, Chain Pulley Blocks etc. and Lifting Tools and Tackles i.e. D shackle, Pulleys, come along clamps, wire rope slings etc. and all types of ropes i.e. Wire ropes, Poly propylene Rope etc. used for lifting purposes along with test certificates.</p>	Yes/No	
4.	<p>Annexure – 3 (SP)</p> <p>List of Personal Protective Equipment (PPE), activity wise including the following along with test certificate of each as applicable:</p> <ol style="list-style-type: none"> 1. Industrial Safety Helmet to all workmen at site. (EN 397 / IS 2925) with chin strap and back stay arrangement. 2. Safety shoes without steel toe to all ground level workers and canvas shoes for workers working on tower. 3. Rubber Gum Boot to workers working in rainy season / concreting job. 4. Twin lanyard Full Body Safety harness with shock absorber and leg strap arrangement 	Yes/No	

S. N.	Details of Enclosure	Status of Submission of information/ documents	Remarks
	<p>for all workers working at height for more than three meters. Safety Harness should be with attachments of light weight such as of aluminium alloy etc. and having a feature of automatic locking arrangement of snap hook and comply with EN 361 / IS 3521 standards.</p> <p>5. Mobile fall arrestors for safety of workers during their ascending / descending from tower / on tower. EN 353 -2 (Guided type fall arrestors on a flexible anchorage line.)</p> <p>6. Retractable type fall arrestor (EN360: 2002) for ascending / descending on suspension insulator string etc.</p> <p>7. Providing of good quality cotton hand gloves / leather hand gloves for workers engaged in handling of tower parts or as per requirement at site.</p> <p>8. Electrical Resistance hand gloves to workers for handling electrical equipment / Electrical connections. IS : 4770</p> <p>9. Dust masks to workers handling cement as per requirement.</p> <p>10. Face shield for welder and Grinders. IS : 1179 / IS : 2553</p> <p>11. Other PPEs, if any, as per requirement etc.</p>		
5.	<p>Annexure – 4 (SP)</p> <p>List of Earthing Equipment / Earthing devices with Earthing lead conforming to IECs for earthing equipments are – (855, 1230, 1235 etc.) gang wise for stringing activity/as per requirement</p>	Yes/No	
6.	<p>Annexure – 5A (SP)</p> <p>List of Qualified Safety Officer(s) along with their contact details</p>	Yes/No	
7.	<p>Annexure – 5B (SP)</p> <p>Details of Explosive Operator (if required), Safety officer / Safety supervisor for every erection / stringing gang, any other person nominated for safety, list of personnel trained in First Aid as well as brief information about safety set up by the</p>	Yes/No	

S. N.	Details of Enclosure	Status of Submission of information/ documents	Remarks
	Contractor alongwith copy of organisation of the Contractor in regard to safety		
8.	Annexure – 6 (SP) Copy of Safety Policy/ Safety Document of the Contractor's company	Yes/No	
9.	Annexure – 7 (SP) 'Emergency Preparedness Plan' for different incidences i.e. Fall from height, Electrocution, Sun Stroke, Collapse of pit, Collapse of Tower, Snake bite, Fire in camp / Store, Flood, Storm, Earthquake, Militancy etc. while carrying out different activities under execution i.e. foundation works including civil works, erection, stringing (as applicable), testing & commissioning, disposal of materials at site / store etc.	Yes/No	
10.	Annexure – 8 (SP) Safety Audit Check Lists (Formats to be enclosed)	Yes/No	
11.	Annexure – 9 (SP) Copy of the module of Safety Training Programs on Safety, Health and Environment, safe execution of different activities of works for Contractor's own employees on regular basis and sub contractor employees.	Yes/No	
12.	Annexure – 10A (SP) Information along with documentary evidences in regard to the Contractor's compliance to various statutory requirements including the following:		
(i)	Electricity Act 2003 _____ [Name of Documentary evidence in support of compliance]	Yes/No	
(ii)	Factories Act 1948	Yes/No	

S. N.	Details of Enclosure	Status of Submission of information/ documents	Remarks
	<p>any, from time to time.</p> <p>_____</p> <p><i>[Name of Documentary evidence in support of compliance]</i></p>		
(x)	<p>The Environment (Protection) Act 1986 and Rules.</p> <p>_____</p> <p><i>[Name of Documentary evidence in support of compliance]</i></p>	Yes/No	
(xi)	<p>Child Labour (Prohibition & Regulation) Act 1986.</p> <p>_____</p> <p><i>[Name of Documentary evidence in support of compliance]</i></p>	Yes/No	
(xii)	<p>National Building Code of India 2005 (NBC 2005).</p> <p>_____</p> <p><i>[Name of Documentary evidence in support of compliance]</i></p>	Yes/No	
(xiii)	<p>Indian standards for construction of Low/ Medium/ High/ Extra High Voltage Transmission Line</p> <p>_____</p> <p><i>[Name of Documentary evidence in support of compliance]</i></p>	Yes/No	
(iv)	<p>Any other statutory requirement(s) <i>[please specify]</i></p> <p>_____</p> <p><i>[Name of Documentary evidence in support of compliance]</i></p>	Yes/No	
13.	<p>Annexure – 10B (SP)</p> <p>Details of Insurance Policies alongwith documentary evidences taken by the Contractor for the insurance coverage against accident for all employees as below:</p>		

S. N.	Details of Enclosure	Status of Submission of information/ documents	Remarks
(i)	Under Workmen Compensation Act 1923 and Rules. <hr/> <i>[Name of Documentary evidence in support of insurance taken]</i>	Yes/No	
(ii)	Public Insurance Liabilities Act 1991 <hr/> <i>[Name of Documentary evidence in support of insurance taken]</i>	Yes/No	
(iii)	Any Other Insurance Policies <hr/> <i>[Name of Documentary evidence in support of insurance taken]</i>	Yes/No	

—

EMPLOYER

ANNEXURE – 6
SAFETY CONDITIONS IN CONTRACT
DOCUMENT

ordered by the Employer consistent with the requirements of the Contract.

PC 21.4 Replace the word 'materials' in line no. 2 with 'Plant and Equipment'.

Add the word 'including liabilities for port charges if any' after the word 'clearance' in line no. 3.

Addition of Sub-Clauses (PC22.2.3.1, PC22.2.3.2, PC22.2.3.3, PC 22.2.3.4) of GC 22.2.3

PC 22.2.3.1 Compliance with Labour Regulations

During continuance of the contract, the Contractor and his sub-contractors shall abide at all times by all applicable existing labour enactments and rules made thereunder, regulations notifications and byelaws of the State or Central Government or local authority and any other labour law (including rules), regulations bye laws that may be passed or notification that may be issued under any labour law in future either by the State or the Central Government or the local authority. The employees of the Contractor and the Sub-contractor in no case shall be treated as the employees of the Employer at any point of time.

PC 22.2.3.2 The Contractor shall keep the Employer indemnified in case any action is taken against the Employer by the competent authority on account of contravention of any of the provisions of any Act or rules made thereunder, regulations or notifications including amendments.

PC 22.2.3.3 If the Employer is caused to pay under any law as principal employer such amounts as may be necessary to cause or observe, or for non observance of the provisions stipulated in the notifications/ byelaws/Acts/ Rules/regulations including amendments, if any, on the part of the Contractor, the Employer shall have the right to deduct any money due to the Contractor under this contract or any other contract with the employer including his amount of performance security for adjusting the aforesaid payment. The Employer shall also have right to recover from the Contractor any sum required or estimated to be required for making good the loss or damage suffered by the Employer.

PC 22.2.3.4 Salient features of some major laws applicable to establishments engaged in building and other construction works are indicated at **Appendix-I** to PC.

Addition of New Sub-Clauses (PC22.4.1 to 22.4.3 including its sub-clauses) of GC 22.4

PC 22.4.1 Protection of Environment

The Contractor shall take all reasonable steps to protect the environment on and off the Site and to avoid damage or nuisance to persons or to property of the public or others resulting from pollution, noise or other

causes arising as consequence of his methods of operation.

During continuance of the Contract, the Contractor and his Sub-contractors shall abide at all times by all existing enactments on environmental protection and rules made there under, regulations, notifications and bye-laws of the State or Central Government, or local authorities and any other law, bye-law, regulations that may be passed or notification that may be issued in this respect in future by the State or Central Government or the local authority.

Salient features of some of the major laws that are applicable are given below:

The Water (Prevention and Control of Pollution) Act, 1974, This provides for the prevention and control of water pollution and the maintaining and restoring of wholesomeness of water. 'Pollution' means such contamination of water or such alteration of the physical, chemical or biological properties of water or such discharge of any sewage or trade effluent or of any other liquid, gaseous or solid substance into water (whether directly or indirectly) as may, or is likely to, create a nuisance or render such water harmful or injurious to public health or safety, or to domestic, commercial, industrial, agricultural or other legitimate uses, or to the life and health of animals or plants or of aquatic organisms.

The Air (Prevention and Control of Pollution) Act, 1981, This provides for prevention, control and abatement of air pollution. 'Air Pollution' means the presence in the atmosphere of any 'air pollutant', which means any solid, liquid or gaseous substance (including noise) present in the atmosphere in such concentration as may be or tend to be injurious to human beings or other living creatures or plants or property or environment.

The Environment (Protection) Act, 1986, This provides for the protection and improvement of environment and for matters connected therewith, and the prevention of hazards to human beings, other living creatures, plants and property. 'Environment' includes water, air and land and the inter-relationship which exists among and between water, air and land, and human beings, other living creatures, plants, micro-organism and property.

The Public Liability Insurance Act, 1991, This provides for public liability insurance for the purpose of providing immediate relief to the persons affected by accident occurring while handling hazardous substances and for matters connected herewith or incidental thereto. Hazardous substance means any substance or preparation which is defined as hazardous substance under Environment (Protection) Act, 1986, and exceeding such quantity as may be specified by notification by the Central Government.

PC 22.4.2

- (i) The Contractor shall (a) establish an operational system of managing environmental impacts, (b) carry out all the monitoring and mitigation measures set forth in the environment management plan attached to the Particular Conditions as Appendix-I, and (c) allocate the budget required

to ensure that such measures are carried out. The Contractor shall submit to the Employer (quarterly) semi-annual) reports on the carrying out of such measures.

- (ii) The Contractor shall adequately record the conditions of roads, agricultural land and other infrastructure prior to transport of material and construction commencement, and shall fully reinstate pathways, other local infrastructure and agricultural land to atleast their pre-project condition upon construction completion.
- (iii) The Contractor shall undertake detailed survey of the affected persons during transmission line alignment finalization under the Project, where applicable. and
- (iv) The Contractor shall conduct health and safety programme for workers employed under the Contract and shall include information on the risk of sexually transmitted diseases, including HIV/AIDS in such programs.

PC 22.4.3 Safety Precautions

PC 22.4.3.1 The Contractor shall observe all applicable regulations regarding safety on the Site.

Unless otherwise agreed, the Contractor shall, from the commencement of work on Site until taking over, provide:

- a) fencing, lighting, guarding and watching of the Works wherever required, and
- b) temporary roadways, footways, guards and fences which may be necessary for the accommodation and protection of Employer / his representatives and occupiers of adjacent property, the public and others.

PC 22.4.3.2 The Contractor shall ensure proper safety of all the workmen, materials, plant and equipment belonging to him or to THE EMPLOYER or to others, working at the Site. The Contractor shall also be responsible for provision of all safety notices and safety equipment required both by the relevant legislations and the Engineer, as he may deem necessary.

PC 22.4.3.3 The Contractor will notify well in advance to the Engineer of his intention to bring to the Site any container filled with liquid or gaseous fuel or explosive or petroleum substance or such chemicals which may involve hazards. The Engineer shall have the right to prescribe the conditions, under which such container is to be stored, handled and used during the performance of the works and the Contractor shall strictly adhere to and comply with such

instructions. The Engineer shall have the right at his sole discretion to inspect any such container or such construction, plant/equipment for which material in the container is required to be used and if in his opinion, its use is not safe, he may forbid its use. No claim due to such prohibition shall be entertained by the Owner and the Owner shall not entertain any claim of the Contractor towards additional safety provisions/conditions to be provided for/constructed as per the Engineer's instructions.

Further, any such decision of the Engineer shall not, in any way, absolve the Contractor of his responsibilities and in case, use of such a container or entry thereof into the Site area is forbidden by the Engineer, the Contractor shall use alternative methods with the approval of the Engineer without any cost implication to THE EMPLOYER or extension of work schedule.

- PC 22.4.3.4 Where it is necessary to provide and/or store petroleum products or petroleum mixtures and explosives, the Contractor shall be responsible for carrying-out such provision and/or storage in accordance with the rules and regulations laid down in Petroleum Act 1934, Explosives Act, 1948 and Petroleum and Carbide of Calcium Manual published by the Chief Inspector of Explosives of India. All such storage shall have prior approval of the Engineer. In case, any approvals are necessary from the Chief Inspector (Explosives) or any statutory authorities, the Contractor shall be responsible for obtaining the same.
- PC 22.4.3.5 All equipment used in construction and erection by Contractor shall meet Indian/International Standards and where such standards do not exist, the Contractor shall ensure these to be absolutely safe. All equipment shall be strictly operated and maintained by the Contractor in accordance with manufacturer's Operation Manual and safety instructions and as per Guidelines/rules of THE EMPLOYER in this regard.
- PC 22.4.3.6 Periodical examinations and all tests for all lifting/hoisting equipment & tackles shall be carried-out in accordance with the relevant provisions of Factories Act 1948, Indian Electricity Act 1910 and associated Laws/Rules in force from time to time. A register of such examinations and tests shall be properly maintained by the Contractor and will be promptly produced as and when desired by the Engineer or by the person authorised by him.
- PC 22.4.3.7 The Contractor shall be fully responsible for the safe storage of his and his Sub-Contractor's radioactive sources in accordance with BARC/DAE Rules and other applicable provisions. All precautionary measures stipulated by

BARC/DAE in connection with use, storage and handling of such material will be taken by the Contractor.

PC 22.4.3.8 The Contractor shall provide suitable safety equipment of prescribed standard to all employees and workmen according to the need, as may be directed by the Engineer who will also have right to examine these safety equipment to determine their suitability, reliability, acceptability and adaptability.

PC 22.4.3.9 Where explosives are to be used, the same shall be used under the direct control and supervision of an expert, experienced, qualified and competent person strictly in accordance with the Code of Practice/Rules framed under Indian Explosives Act pertaining to handling, storage and use of explosives.

PC 22.4.3.10 The Contractor shall provide safe working conditions to all workmen and employees at the Site including safe means of access, railings, stairs, ladders, scaffoldings etc. The scaffoldings shall be erected under the control and supervision of an experienced and competent person. For erection, good and standard quality of material only shall be used by the Contractor.

PC 22.4.3.11 The Contractor shall not interfere or disturb electric fuses, wiring and other electrical equipment belonging to the Owner or other Contractors under any circumstances, whatsoever, unless expressly permitted in writing by THE EMPLOYER to handle such fuses, wiring or electrical equipment

PC 22.4.3.12 Before the Contractor connects any electrical appliances to any plug or socket belonging to the other Contractor or Owner, he shall:

- a. Satisfy the Engineer that the appliance is in good working condition;
- b. Inform the Engineer of the maximum current rating, voltage and phases of the appliances;
- c. Obtain permission of the Engineer detailing the sockets to which the appliances may be connected.

PC 22.4.3.13 The Engineer will not grant permission to connect until he is satisfied that:

- a. The appliance is in good condition and is fitted with suitable plug;
- b. The appliance is fitted with a suitable cable having two earth conductors, one of which shall be an

earthed metal sheath surrounding the cores.

- PC 22.4.3.14 No electric cable in use by the Contractor/Owner will be disturbed without prior permission. No weight of any description will be imposed on any cable and no ladder or similar equipment will rest against or attached to it.
- PC 22.4.3.15 No repair work shall be carried out on any live equipment. The equipment must be declared safe by the Engineer and a permit to work shall be issued by the Engineer before any repair work is carried out by the Contractor. While working on electric lines/equipment, whether live or dead, suitable type and sufficient quantity of tools will have to be provided by the Contractor to electricians/workmen/officers.
- PC 22.4.3.16 The Contractors shall employ necessary number of qualified, full time electricians/electrical supervisors to maintain his temporary electrical installation.
- PC 22.4.3.17 The Contractor employing more than 250 workmen whether temporary, casual, probationer, regular or permanent or on contract, shall employ at least one full time officer exclusively as safety officer to supervise safety aspects of the equipment and workmen, who will coordinate with the Project Safety Officer. In case of work being carried out through Sub-Contractors, the Sub-Contractor's workmen/employees will also be considered as the Contractor's employees/workmen for the above purpose.
- The name and address of such Safety Officers of the Contractor will be promptly informed in writing to Engineer with a copy to Safety Officer-In charge before he starts work or immediately after any change of the incumbent is made during currency of the Contract.
- PC 22.4.3.18 In case any accident occurs during the construction/erection or other associated activities undertaken by the Contractor thereby causing any minor or major or fatal injury to his employees due to any reason, whatsoever, it shall be the responsibility of the Contractor to promptly inform the same to the Engineer in prescribed form and also to all the authorities envisaged under the applicable laws.
- PC 22.4.3.19 The Engineer shall have the right at his sole discretion to stop the work, if in his opinion the work is being carried out in such a way that it may cause accidents and endanger the safety of the persons and/or property, and/or equipment. In such cases, the Contractor shall be informed in writing about the nature of hazards and

possible injury/accident and he shall comply to remove shortcomings promptly. The Contractor after stopping the specific work can, if felt necessary, appeal against the order of stoppage of work to the Engineer within 3 days of such stoppage of work and decision of the Engineer in this respect shall be conclusive and binding on the Contractor.

PC 22.4.3.20 The Contractor shall not be entitled, for any damages/compensation for stoppage of work due to safety reasons as provided in para GCC 22.4.3.19 above and the period of such stoppage of work will not be taken as an extension of time for completion of work and will not be the ground for waiver of levy of liquidated damages.

PC 22.4.3.21 It is mandatory for the Contractor to observe during the execution of the works: requirements of Safety Rules which would generally include but not limited to following:

Safety Rules.

- a) Each employee shall be provided with initial indoctrination regarding safety by the Contractor, so as to enable him to conduct his work in a safe manner.
- b) No employee shall be given a new assignment of work unfamiliar to him without proper introduction as to the hazards incident thereto, both to himself and his fellow employees.
- c) Under no circumstances shall an employee hurry or take unnecessary chance when working under hazardous conditions.
- d) Employees must not leave naked fires unattended. Smoking shall not be permitted around fire prone areas and adequate fire fighting equipment shall be provided at crucial location.
- e) Employees under the influence of any intoxicating beverage, even to the slightest degree shall not be permitted to remain at work.
- f) There shall be a suitable arrangement at every work site for rendering prompt and sufficient first aid to the injured.
- g) The staircases and passageways shall be adequately lighted.
- h) The employees when working around moving machinery, must not be permitted to wear loose

EMPLOYER employees or any other person who are at Site or adjacent thereto, then the Contractor shall be responsible for payment of a sum as indicated below to be deposited with THE EMPLOYER, which will be passed on by THE EMPLOYER to such person or next to kith and kin of the deceased:

a.	Fatal injury or accident causing death	Rs. 1,000,000/- per person
b.	Major injuries or accident causing 25% or more permanent disablement	Rs. 100,000/- per person

Permanent disablement shall have same meaning as indicated in Workmen's Compensation Act. The amount to be deposited with THE EMPLOYER and passed on to the person mentioned above shall be in addition to the compensation payable under the relevant provisions of the Workmen's Compensation Act and rules framed there under or any other applicable laws as applicable from time to time. In case the Contractor does not deposit the above mentioned amount with THE EMPLOYER, such amount shall be recovered by THE EMPLOYER from any monies due or becoming due to the Contractor under the contract or any other on-going contract.

PC22.4.3.25 If the Contractor observes all the Safety Rules and Codes, Statutory Laws and Rules during the currency of Contract awarded by the Owner and no accident occurs then THE EMPLOYER may consider the performance of the Contractor and award suitable 'ACCIDENT FREE SAFETY MERITORIOUS AWARD' as per scheme as may be announced separately from time to time.

PC22.4.3.26 The Contractor shall also submit 'Safety Plan' as per proforma specified in Section IX: Contract Forms, Part-3 of Bidding Documents alongwith all the requisite documents mentioned therein and as per check-list contained therein to the Engineer In-Charge for its approval within 60 days of award of Contract.

Further, one of the conditions for release of first progressive payment / subsequent payment towards Services Contract shall be submission of 'Safety Plan' alongwith all requisite documents and approval of the same by the Engineer In-Charge.

PC 22.6 Emergency Work (GC Clause 22.6)

Replace the words "Otherwise" with "In case such work is not in the scope of the Contractor", in the second last line of second paragraph of GC clause 22.6.

PC 23.3 Supplementing sub-clause GC 23.3

For notification of testing, four weeks shall be deemed as reasonable advance notice.

PC 23.7 Test and Inspection (GC Clause 23.7)

Replace the words "GC Sub-Clause 6.1" with "GC Sub-Clause 46.1", in the last line of GC clause 23.7.

PC 24 Replace the marginal words/headings 'Completion of the Facilities' with 'Pre Commissioning'**PC 24.5 Replace sub clause GC 24.5 with the following:**

The Project Manager shall, within fourteen (14) days after receipt of the Contractor's notice under sub clause GC 24.4, notify the Contractor in writing of any defects and/or deficiencies.

If the Project Manager notifies the Contractor of any defects and/or deficiencies, the Contractor shall then correct such defects and/or deficiencies, and shall repeat the procedure described in sub clause GC 24.4. If the Project Manager is satisfied that the Facilities or that part thereof have passed Pre-commissioning, the Project Manager shall, within fourteen (14) days after receipt of the Contractor's notice/ seven (7) days after receipt of the Contractor's repeated notice, advise the Contractor to proceed with the Commissioning of the Facilities or that part thereof. If the Project Manager is not so satisfied, then it shall notify the Contractor in writing of any defects and/or deficiencies within seven (7) days after receipt of the Contractor's repeated notice, and the above procedure shall be repeated.

PC 24.6 Replacing Sub-Clause GC 24.6

If the Project Manager fails to advise the Contractor to proceed with the Commissioning of the Facilities or the relevant part thereof or inform the Contractor of any defects and/or deficiencies within fourteen (14) days after receipt of the Contractor's notice under GC Sub-Clause 24.4 or within seven (7) days after receipt of the Contractor's repeated notice under GC Sub-Clause 24.5, then the Facilities or that part thereof shall be deemed to have passed Precommissioning, as of the date of the Contractor's notice or repeated notice, as the case may be.

PC 24.7 Replace the word 'Completion' with 'Pre-commissioning' in the 1st line of sub clause GC 24.7

ANNEXURE - 7
HEALTH AND SAFETY CHECKLIST

HEALTH AND SAFETY CHECKLIST

Safety Related Check List during Construction of Transmission Lines/Distribution Lines

Region: Date of Safety Audit:.....

Name of Transmission/Distribution Line:
.....
.....

Loc. No: Voltage Level:

Name of Contractor:

Contractor License / Registration No.:..... Validity.....

Name of Sub Contractor :

Sub-Contractor License / Registration
No.:..... Validity.....

I. DURING TOWER FOUNDATION :

SN	Description of Activity	Feed back	Remarks
i) Excavation :			
1.	Dumping of Excavated soil. (Minimum 1.5 Mts. or half the depth of the pit which ever is more)	Yes / No.	
2.	Whether angle of repose of soil as per design in the foundation is maintained or not.	Yes / No.	
3.	De watering arrangement is available (If necessary)	Yes / No.	
4.	Working area has been protected properly to avoid against fall of passerby or animal in the excavated pit.	Yes / No.	
5	Shoring & Shuttering to protect the loose rock / soil against fall exists.	Yes / No.	
6	Arrangement of illumination at construction site is available. (if required)	Yes / No.	
7	Check proper/adequate arrangement is made for extension of electric supply. (Proper size of cable, Use of fuse, No loose connection for De-watering Pumps/ Illumination / Electric compressors etc. if applicable).	Yes / No.	
8	Check for damage / Uneven settlement of foundation.	Yes / No.	
9	Ensure Life saver arrangements have been made during construction of well foundation in river bed. (Where necessary)	Yes / No.	
10	Check that the adequate arrangement is made for the storage of blasting material at safe place. (if required)	Yes / No.	

SN	Description of Activity	Feed back	Remarks
11	Check that the blasting materials is handled with due care at site. (If required)	Yes / No.	
12	Check that during blasting operation, Labour / Workmen / Passerby are at safe places and arrangement is made to inform public by caution markings (Red Flag) / Public Notices.	Yes / No.	
13	Check that the Blaster is holding the proper license issued by the appropriate authority. as per the Indian Explosive Act.	Yes / No.	
14	Check that the length of the fuse wire used during blasting operation is adequate.	Yes / No.	
15	Ensure Laying of temporary cable used for operation of Machines used during construction should not cause any danger for electrocution of workmen.	Yes / No.	
16	Check that PPEs i.e. Safety helmets, Safety Shoes, is used by blaster and their gang members during blasting.	Yes / No.	
17	Ensure that Shuttering and timbering has been made as detailed in I:S: 3764.	Yes / No.	
18	Ensure that before undertaking excavation, the soil has been tested and in case of availability of any explosive / dangerous gas, necessary arrangement must be made to remove / dilute such gases.	Yes / No.	
19	The positions of underground installations such as sewers, water pipes and electrical cables have been verified and in case of their existence, they must be isolated.	Yes / No.	
20	Arrangement shall be made to prevent external vibrations due to rail / road traffic (If required).	Yes / No.	
21	Safety is ensured during the construction of Tr. Lines for buildings, structures etc. which are coming in the vicinity of the excavated area from collapse. (If required)	Yes / No.	
22	Check that sufficient strong ladder of suitable length is available for ingress / outgress of persons in the pit	Yes / No.	
23	Lone worker should not be allowed to work in the excavated area beyond shoulder level.	Yes / No.	
24	Check for any possibility of seepage of water from nearby pond / river should be estimated and taken care of.	Yes / No.	
25	After excavation the work has been completed speedily and back filling done at the earliest.	Yes / No.	
ii) Casting of Foundation / Concreting :			
1	Check construction materials are stacked at safe place and also does not cause any danger. (Away from pit by 1.5 Mtrs. Or half the depth of pit, which ever is more.)	Yes / No.	
2	Check arrangement of illumination at Construction Site. (If required).	Yes / No.	
3	Ensure life saver arrangements have been made during construction of Well foundation in River Bed.	Yes / No.	

SN	Description of Activity	Feed back	Remarks
4	Check that the Concreting Mixer machine is placed at a safe place. (Not very near to pit.)	Yes / No.	
5	Check proper / adequate arrangement is made for extension of electric supply. (Proper size of cable, Use of fuse, No loose connection for De watering Pumps / Illumination / Electric compressors etc. if applicable).	Yes / No.	
6	Check that laying of temporary cables used during construction activities should not cause any danger for electrocution to workmen.	Yes / No.	
7	Inspection of excavations shall be made by a Competent Person every day. In case, possible cave in or slide is apparent, all working in the excavation shall be seized until the necessary precautions have been taken to safeguard the possible cave in or slide.	Yes / No.	
8	Jacks and vertical supports shall be positioned in such a manner that the vertical loads are distributed equally and do not exceed the capacity of the jacks and the jacks are placed away from pit edge etc.	Yes / No.	
9	Proper Jacking arrangement is made to take the entire load of template.	Yes / No.	
10	In case of long template in stub setting, more jacks have been provided and check that the Jacks are placed on levelled and hard surface to avoid the unbalancing and fallen.	Yes / No.	
11	Wire mesh rolls shall be secured in order to prevent dangerous recoiling action.	Yes / No.	
12	Lone worker should not be allowed to work in the excavated area.	Yes / No.	
13	Check that sufficient strong ladder of suitable length is available for ingress / outgress of persons in the pit	Yes / No.	

II. TOWER ERECTION :

SN	Description of Activity	Feed back	Remarks
1	Check proper communication facility is available at site during Tower erection. (If required)	Yes / No.	
2.	Check damages or uneven settlement of foundation.	Yes / No.	
3.	Ensure the derrick used before tower erection has been checked for adequate strength/ size. Ensure for copy of test certificate for all the lifting machines and tackles.	Yes / No.	
4.	Ensure that the pulleys used before tower erection has been checked for adequate strength / proper size (diameter). Also in case of open type pulleys proper locking arrangements like providing of Safety Pin is made. Ensure for copy of test certificate for all the lifting machines and tackles.	Yes / No.	
5.	Ensure that the ropes used before tower erection has been checked for adequate strength / physical	Yes / No.	

SN	Description of Activity	Feed back	Remarks
	condition (Free from break of strands and knots etc.		
6.	Check that the lifting tools and tackles i.e. Winch Machine, Chain Pulley Block, Trifor, D - Shackle etc. are in healthy condition and has been tested periodically. (Attach copy of test certificate).	Yes / No.	
7.	Ensure that permission has been obtained from Aviation Authority for erection of special towers. (Where necessary).	Yes / No.	
8.	Ensure that permission has been obtained form Aviation Authority for erection of towers which comes in the vicinity of flying zone. (Where necessary)	Yes / No.	
9.	Check that the safety measures has been taken before undertaking for the Road / Rail / River Xing jobs involving like wise stretches.	Yes / No.	
10.	For rail or road crossing check whether written working plan is available at site with specific reference to safety e.g. local earthing, skilled & experience manpower, proper T&P, strength and height of scaffolding to maintain the required clearance etc.	Yes / No.	
11.	Ensure that all the members and proper size of Nuts and Bolts of lower section are fitted properly before erection of the upper section of tower is taken up.	Yes / No.	
12.	Check that the anti climbing devices are provided in the tower after erection job.	Yes / No.	
13.	Check that the danger plates have been provided.	Yes / No.	
14.	Check that only erection team members are allowed to stand near the tower while erection is in process and should wear the safety helmet / Safety Shoes.	Yes / No.	
15.	Working area of the tower has been demarcated during erection.	Yes / No.	
16	Check that proper guying arrangement has been made. And also to see that proper size of the crow bars has been used which has been fixed at hard surface in case of sandy soil or loose soil.	Yes / No.	
17	Check that proper arrangement is made while lifting the tower members and fixing them at height i.e. Proper size and strength of the hook used for lifting the tower members.	Yes / No.	
18	Check sufficient numbers of guys are made while lifting the assembled cross arm and also avoiding use of single sheeve pulleys while lifting the assembled cross arm / heavy load.	Yes / No.	

III. CONDUCTOR STRINGING:

SN	Description of Activity	Feed back	Remarks
1.	All drivers and plant operators are holding the valid driving license.	Yes / No.	
2.	Check that the permit has been obtained from the	Yes / No.	

SN	Description of Activity	Feed back	Remarks
	Competent Authority for stringing of conductor while crossing through Road / Rail / River / Venerable areas etc. (Where necessary)		
3.	Check that required painting has been made on tower falling in the vicinity of aviation zones. (Where necessary.)	Yes / No.	
4.	Check that all safety measures have been taken during stringing of conductor crossing the EHV / HV / LT lines (Earthing of existing lines etc.)	Yes / No.	
5.	Ensure that proper size of Nuts and Bolts is rigidly tightened and punching / tacking / tack welding is done in towers before undertaking stringing job.	Yes / No.	
6.	Ensure that proper scaffolding arrangements made during stringing of conductor (While Road Xing / Power Line Xing etc.	Yes / No.	
7.	Ensure that all members are fitted in tower before undertaking conductor stringing work.	Yes / No.	
8.	Check that the back filling of the foundation has been done as per specification.	Yes / No.	
9.	Ensure that the discharge rod is electrically tested before use.	Yes / No.	
10.	Stringing Machine / Tension pullor Machine are properly earthed.	Yes / No.	
11.	Check the brake arrangement of the TSE Machines is working.	Yes / No.	
12.	Ensure that the pulleys used before conductor stringing has been checked for adequate strength / proper size (diameter), also in case of open type pulleys proper locking arrangements like providing of Safety Pin is made Ensure for copy of test certificate for all the lifting machines and tackles.	Yes / No.	
13.	Ensure the ropes used before conductor stringing has been checked for adequate strength / physical condition (Free from break of strands and knots etc.	Yes / No.	
14.	Check that the lifting tools and tackles i.e. Winch Machine, Chain Pulley Block, Trifor, D - Shackle etc. are in healthy condition and has been tested periodically. (Attach copy of test certificate).	Yes / No.	
15.	Check for the brake arrangement of the Drum reel of conductor during laying / paying out of conductor.	Yes / No.	
16.	Check that proper communication facility is available at site during of stringing of conductor (If required)	Yes / No.	
17.	Whether the tower has been permanently earthed.	Yes / No.	
18.	Check that Sag Board is provided at two locations.	Yes / No.	
19.	Check that the Sag Board arrangement is made by the experienced / trained persons.	Yes / No.	
20.	Check approved Sag tension chart is available and followed at site.	Yes / No.	
21.	While clamping of conductor / EW to be done, check for earthing.	Yes / No.	

SN	Description of Activity	Feed back	Remarks
22.	Ensure sending signal to puller to stop when last layer of conductor / EW being pulled.	Yes / No.	
23.	Check tension applied on the dynamo meter dial and check values with approved data.	Yes / No.	
24.	Before stringing starts check that the villagers do not come underneath the job of the concerned section.	Yes / No.	
25.	Only nylon or polypropylene ropes should be used during conductor stringing in vicinity of live overhead lines.	Yes / No.	
26.	Ensure that PTW has been taken from the concerned authority.	Yes / No.	
27.	Ensure that Winch, Pulleys etc. are properly earthed.	Yes / No.	
28.	For LT lines, whether special persons are posted at each point of isolation till return of permit (PTW).	Yes / No.	
29.	Whether the network of LT lines has been thoroughly checked and precautions taken Against inadvertent charging.	Yes / No.	
30.	Check that proper arrangement is made / available for development and use of a Portable Earthing and Short – Circuiting Devices which can be engaged and disengaged to and from the LT lines, keeping away from the LT lines, until all operations on the same are completed and all men and materials are removed from LT lines.	Yes / No.	
31.	Check the provision and proper positioning for the guying and back staying (Where necessary).	Yes / No.	
32.	Check demarcation of feeder is done for D/c Line.	Yes / No.	
33.	Ensure that all the insulator strings are thoroughly checked for availability and proper fixing of cotter / split pins before hoisting the same.	Yes / No.	

General Points common for all activities during Excavation, Casting of Foundation

I. ERECTION OF TOWER AND STRINGING OF CONDUCTOR :

SN	Description of Activity	Feed back	Remarks
1.	Check whether the contractor had procured required quantity of PPEs considering maximum numbers of erection gangs deployed at one time.	Yes / No.	
2.	Supervisors/ Workmen have been provided with required healthy PPEs, like Safety helmet / Safety Belts / Safety Shoes / Gum Boot etc. as applicable.	Yes / No.	
3.	Availability of First Aid Box with required medicines at site.	Yes / No.	
4.	Instruction register is available at site.	Yes / No.	

5.	Ensure that Supervisor / Gang Leader always issues instruction to the Workmen before start of work.	Yes / No.	
6.	Ensure that supervisory staff from Power Grid is available at site during construction.	Yes / No.	
7.	All driver and plant operators are holding valid driving license.	Yes / No.	
8.	Check the vehicle for rescue is available at site.	Yes / No.	
9.	Ensure engaged labour are aware of the job.	Yes / No.	
10.	Check that the unskilled labourers are not engaged in skilled job.	Yes / No.	
11.	Ensure that supervisor / workmen engaged in the field are aware of First Aid Techniques (Such as in case of Electric Shock, Fall from the height, Snake bite and the person rescued from buried under the debris etc.	Yes / No.	
12.	Check for nearby Hospital / Doctor in case of emergencies arises.	Yes / No.	
13.	While transporting heavy consignment of conductor / EW drums from central store to site by the use of Cranes, Truck, and Tractor. The safety aspect for construction and failure of brake system of moving machinery is to be checked.	Yes / No.	
14.	At least one dry powder type of portable fire extinguisher shall be provided especially where explosive or blasting agents are used for excavation.	Yes / No.	
15.	Check the competence (Qualification / Experience) of supervisor / gang leader of contractor.	Yes / No.	

ARKS IF ANY:

Signature	Signature	Signature
Name : Designation : Representative of Contractor	Name : Designation: TSECL Rep. from Site.	Name : Designation: TSECL Rep. from Circle Office.

Safety Related Check List during Construction of Sub - Station

Region: Date of Safety Audit:.....

Name of Sub Stn. / Switching Stn.:
.....

Name of Contractor:

Contractor License / Registration No.:.....Validity.....

Name of Sub Contractor :
.....

Sub-Contractor License / Registration
No.:.....Validity.....

I. SUB STATION CIVIL WORKS :

SN	Description of Activity	Feed back	Remarks
i): Safety during Excavation :			
1.	Check Sub station area has been protected by constructing boundary wall all around the sub station to avoid entry of passerby / unauthorized person or animal in the sub station.	Yes / No.	
2.	De watering arrangement is available (If necessary)	Yes / No.	
3.	Check proper / adequate arrangement is made for extension of electric supply. (Proper size of cable, Use of fuse, No loose connection and no naked wire connection to Pumps / Illumination / Electric compressors etc. if applicable).	Yes / No.	
4.	Check arrangement of illumination at construction site is available.	Yes / No.	
5.	Check dumping of Excavated soil (Minimum 1.5 Mts. Or half the depth of the pit which ever is more from the edge of the pit.)	Yes / No.	
6.	Check Shoring & Shuttering to protect the loose rock / soil against fall. (if required).	Yes / No.	
7.	Check lone worker is not be allowed to work in the excavated area.	Yes / No.	
8.	Ensure Laying of temporary cables used for operation of Machines used during construction should not cause any danger for electrocution of persons / animals.	Yes / No.	
9.	Ensure that before undertaking excavation, the soil has been tested and in case of availability of any explosive / dangerous gas, necessary arrangement must be made to remove / dilute such gases.	Yes / No.	
10.	The positions of underground installations such as sewers, water pipes and electrical cables has been verified and in case of their existence, they must be isolated before further excavation works to ensure	Yes / No.	

SN	Description of Activity	Feed back	Remarks
	Human Safety.		
11.	Check that the scaffolds are not overloaded in any case. Scaffolds are to be erected and supported properly.	Yes / No.	
12.	Stability of the soil of the excavated pit for safe working is to be checked and certified by a competent person daily before start of work. A register at site is maintained where competent person can certify accordingly. No manhole should remain uncovered during night & off days.	Yes / No.	
13.	Check the provision of sufficient strong ladder of suitable length is available near the working place during excavation.	Yes / No.	
14.	Check if any permission is required from local statutory body before excavation.	Yes / No.	
15.	Check for No undercutting / toe cutting in soil.	Yes / No.	
16.	Check after excavation the work should be speedily completed without delay and back filling done at the earliest.	Yes / No.	
17.	Check for any possibility of seepage of water from nearby pond / river has been estimated and taken care of.	Yes / No	
18.	Check to avoid slide / collaps of side walls of excavated pit, the excavation is to be done in trapezoidal cross – section.	Yes / No.	
ii): Safety precaution during Storage, Handling and Use of Blasting Material:			
1	Check that the adequate arrangement is made for the storage of blasting material at safe place. (Temporary Magazine is to be installed observing all norms) as per Indian Explosive Act.	Yes / No.	
2.	Check that the blasting materials is handled by licensed blaster with due care at site. (If applicable)	Yes / No.	
3.	Check smoking is prohibited in the vehicle carrying explosives.	Yes / No.	
4.	Check that the Blaster is holding proper license issued by the appropriate authority. As per Indian Explosive Act.	Yes / No.	
5.	Check that the length of the fuse wire used during blasting operation is adequate.	Yes / No.	
6.	Check while transportation, no unauthorized person is allowed in vehicle carrying explosives.	Yes / No.	
7.	Check that the loading and unloading of explosives is being done carefully.	Yes / No.	
8.	Check explosives and detonators or blasting caps is not being transported in the same vehicle.	Yes / No.	
9.	Check while transportation the detonators and explosives are not carried loose or mixed with other materials.	Yes / No.	
10	Check surplus explosives shall not be stacked near working area during loading / unloading.	Yes / No.	
11.	Check explosives shall not be held in hands when lightening the fuse.	Yes / No.	
12.	Check that blasting in the open has been carried out	Yes / No.	

SN	Description of Activity	Feed back	Remarks
	during the fixed hours every day or on fixed days in the week so that the public at large should know about this.		
13.	Check that arrangement has been made to display sufficient warnings / sign board to enable the people to get out of the blasting area to get off the danger zone	Yes / No.	
14.	Check that the danger zone has been suitably cordoned off.	Yes / No.	
15.	Check during blasting operations begin / after the firing of explosives shall follow the loud siren.	Yes / No.	
16.	Check that during blasting operation, Labour / Workmen / Passerby are at safe places and arrangement is made to inform public by caution markings (Red Flag) / Public Notices etc.	Yes / No.	
17.	Check that PPEs i.e. Safety helmets, Safety Shoes, is used by blaster and their gang members during blasting and also the persons supervising the blasting operations.	Yes / No.	
18.	For covered blasting ensure placement of cover plates of proper thickness and sufficient numbers of sand filled bags.	Yes / No.	
19.	Ensure that permission for blasting has been obtained from the appropriate authority.	Yes / No.	
iii) Safety during casting of Foundation / Concreting :			
1.	Check construction materials are stacked at safe place and also does not cause any danger. (Away from pit) i.e. 1.5 Mtrs. or half the depth of the pit which ever is more.)	Yes / No.	
2.	Check proper arrangement of illumination at Construction Site of Sub station is available.	Yes / No.	
3.	Check that the Concreting Mixer/ Vibrator machines etc are placed at a safe place (Not very near to any pit at least 1.5 Mtr. from the edge of the pit) to avoid transfer of vibrations and should be operated by skilled persons.	Yes / No.	
4.	Check proper / adequate arrangement is made for extension of electric supply. (Proper size of cable, Use of fuse, No loose connection for De watering Pumps / Illumination / Electric compressors etc. if applicable).	Yes / No.	
5.	Check for laying of temporary cables used during construction activities should not cause any danger for electrocution to persons / animals.	Yes / No.	
6.	All bracing, struts and shuttering in excavations shall be adequately secured so as to prevent their accidental displacement.	Yes / No.	
7.	Ensure Shuttering and timbering has been made as detailed in I:S: 3764 for protecting the loose rock / soil against fall.	Yes / No.	
8.	Check for proper placing of Hydraulic jacks with stability and constant watch of these instruments (which are continuously loaded) to avoid any danger of displacement causing sever accident.	Yes / No.	

II. SAFETY DURING STRUCTURE, EQUIPMENT ERECTION & CABLE LAYING ETC. :

SN	Description of Activity	Feedback	Remarks
1.	Check Back filling done prior to erection activity.	Yes / No.	
2.	Check the derrick used before structure erection has been checked for adequate strength / size and no joints are permitted.	Yes / No.	Test certificate is required apart from visual inspection.
3.	Check that the pulleys used before structure erection / Equipment Erection has been checked for adequate strength / proper size (diameter), also in case of open type pulleys proper locking arrangements like providing of Safety Pin is made Safe working load should be punched.	Yes / No.	Test certificate is required apart from visual inspection.
4.	Check the ropes used before structure erection / Equipment Erection has been checked for adequate strength / physical condition (free from break of strands and knots etc.	Yes / No.	Test certificate is required apart from visual inspection.
5.	Check that the lifting tools and tackles are in healthy condition and has been tested periodically.	Yes / No.	Test certificate is required apart from visual inspection.
6.	Check permission has been obtained from Aviation Authority for erection of Lightning Mast which comes in the vicinity of flying zone. (Where necessary)	Yes / No.	
7.	Check that all Nuts and Bolts are fitted in the structure before undertaking the job of other section of the structure and are tightened.	Yes / No.	
8.	Check area has been cordoned off to prevent injuries to unauthorized persons from hitting against structural component or falling in the excavated pits.	Yes / No.	
9.	Check that danger plates are available on all the equipment & structures in the switchyard.	Yes / No.	
10.	Check demarcation of feeder is done for Double Circuit Line.	Yes / No.	
11.	Check only erection team members are allowed to stand near the structure / Equipment while erection is in process and should wear the safety helmet / Safety Shoes.	Yes / No.	
12.	Check proper guying arrangement has been made while lifting structure / Equipment, if necessary.	Yes / No.	
13.	Check that proper arrangement is made while lifting the structure members and fixing them at height i.e. Proper size and strength of the hook used for lifting the structure members.	Yes / No.	
14.	Check sufficient numbers of guys are made while lifting the assembled structure / heavy loads and also avoiding use of single sheeve pulleys while lifting the assembled structure / heavy load.	Yes / No.	
15.	Check arrangement has been made for equipment identification.	Yes / No.	
16.	Check that required painting made on tower falling in the vicinity of aviation zones. (Where necessary.)	Yes / No.	
17.	Check no live wires nearby. Take shut down if necessary.	Yes / No.	

SN	Description of Activity	Feedback	Remarks
18.	Check the structure has been permanently earthed.	Yes / No.	
19.	Check crane are preferably be used for erection of pipe structure in the sub station building works (if required.)	Yes / No.	
20.	Check all safety procedures for erection work like use of safety helmets, Safety belts, use of guy wires, lowering / lifting of tools by rope etc. are strictly adhered to during structure erection works is in progress in the switchyard.	Yes / No.	
21.	Check that correct size of spanner (Box or ring type) as well as DE spanners is being used.	Yes / No.	
22.	Check working area of the structure has been demarcated during erection.	Yes / No.	
23.	Check heavy structures are lifted with crane with proper safety.	Yes / No.	
24.	Only polypropylene ropes are to be used to tie the aluminium tube / Bus bar since this is soft material and will not damage aluminium tube / Bus bar during erection.	Yes / No.	
25.	Ensure that R clips in insulator caps are fixed properly to avoid disconnection of insulator discs.	Yes / No.	
26.	Ensure that all the necessary security pins (split pins) are fixed.	Yes / No.	
27.	Check all nuts of jumper fittings are properly tightened and live metal clearance have been maintained as per POWERGRID specification.	Yes / No.	
28.	In case of tension fitting dead end joint dimensions before & after the compression are checked and recorded.	Yes / No.	
29.	No damaged component of any hardware fitting should be used on works.	Yes / No.	
30.	Length of jumpers has been measured properly to give it a parabolic shape. No sharp bend should exist.	Yes / No.	
31.	Check surge counter erection facilitates proper reading and that earthing is done with minimum bends.	Yes / No.	
32.	Check Surge monitor has been earthed by connecting it to main earth mat with (G I Flat 75 x 12 mm) and earth pit separately as per drawing.	Yes / No.	
33.	Check the alignment of earth switch with isolator, earth switch of isolator is put into operation and the contacts are cleaned. After completion of pre commissioning checks and formats are dully filled and signed.	Yes / No.	
34.	Ensure that the rubber beedings are kept in good condition.	Yes / No.	
35.	Check CT has been placed on the support structure very carefully and all nuts have been tightened. Earthing is done as per drawing.	Yes / No.	
36.	Ensure the lattice structure of CT has been earthed at two points.	Yes / No.	
37.	Check the marshalling box in the switchyard has proper illumination arrangement.	Yes / No.	
38.	Check the capacitor unit is short circuited & earthed, until erection and commissioning works are being done on CVT. (The capacitor get charged by the electrical fields in the vicinity and they keep these charges for a long time,	Yes / No.	

SN	Description of Activity	Feedback	Remarks
	which can be dangerous to human life. Hence the shorting of capacitor unit is necessary). It should be removed before tests / use.		
39.	Check Fuses in the marshaling box are OK.	Yes / No.	
40.	Check proper earthing of CVT tank has been done.	Yes / No.	
41.	Check all housing accessories, mounting stools including bolts / Nuts for fixing Line Trap and insulators are of non magnetic material.	Yes / No.	
42.	Check H.F. point of CVTs on which the coupling device is not mounted has been earthed.	Yes / No.	
43.	Check the remaining CVTs have been earthed thro' coupling device.	Yes / No.	
44.	Cable drums after visual inspection should be stored preferably in the covered area. Cable ends should be clamped.	Yes / No.	
45.	Ensure each cable and conduit run should be tagged with cable identity numbering as per the approved that appear in the cable and conduit schedule.	Yes / No.	
46.	The tag should be of aluminium plate with ID number punched on it and securely attached to the cable conduit by not less than two turns. Cable tags should of rectangular shape for power cables and of circular shape for control cables.	Yes / No.	
47.	Check underground cable markers should project 150 mm above ground and spaced at an interval of 30 Mts. They shall be located on both sides of road and drain crossing and also at every change in direction.	Yes / No.	
48.	Check cable tags should be provided inside the switchgear, motor control centres, control and relay panels etc. wherever required for cable identification, where a number of cables enter together through a gland plate.	Yes / No.	
49.	The cable (power and control) between LT stations, Control room, DG set building and fire fighting pump house should be laid in the buried cable trenches. In addition to the above, for lighting purpose also, buried cable trench can be used in outdoor area. (as per Technical specification of specific contract)	Yes / No.	
50.	Cable route and joint markers and RCC warning covers should be provided wherever required. The voltage grade of cables should be engraved on the marker.	Yes / No.	
51.	Tray Identification Number on each run of trays at an interval of 10 Mtrs should be painted.	Yes / No.	
52.	In case the outer sheath of a cable is damaged during handling / installation, the same should be repaired to the satisfaction of the site. In case any other part of a cable is damaged, the same should be replaced by a healthy cable. Power cables should be at the top most layers. The armor of control cable is to be earthed.	Yes / No.	
53.	All cable termination should be appropriately tightened to ensure secure and reliable connections. All the exposed	Yes / No.	

SN	Description of Activity	Feedback	Remarks
	parts of cable lugs should be covered with tape, sleeve or paint.		
54.	Power and control cables are laid on separate cable trays	Yes / No.	
55.	Co-axial cable is laid separately from power cable.	Yes / No.	
56.	All cable trays, racks and metallic ducts have been grounded by connecting each to earth / mat. (As per Scheme)	Yes / No.	
57.	Check sections of cable trays have been bridged by copper jumpers/ G I to retain continuity of earthing. (As per Scheme)	Yes / No.	
58.	Check earthing of panel is done by the erection contractor for connecting it with switchyard earth mat. (As per Scheme)	Yes / No.	
59.	Auxiliary bus wiring for AC and DC supplies, Voltage Transformer circuits, annunciation circuits and other common services is provided near the top of the panels running through out the entire length of the panels.	Yes / No.	
60.	All internal wiring to be connected to external equipment is terminated on terminal blocks, preferably vertically mounted on the side of each panel.	Yes / No.	
61.	Check whether Mimic Diagram is available preferably made of anodized aluminium or plastic of approved fast colour material and screwed on to the panel that can be easily cleaned.	Yes / No.	
62.	Check the panels all equipment mounted on front and rear side as well as equipment mounted inside are provided with individual name plates with equipment designated engraved.	Yes / No.	
63.	Check on top of each panel on front as well as rear side, large and bold name plates are provided for circuit / feeder designation.	Yes / No.	
64.	Check all front mounted equipments are provided at the rear with individual name plates engraved with tag numbers corresponding to panel internal wiring to facilitate easy tracing of the wiring.	Yes / No.	
65.	Check the name plates mounted directly by the side of the respective equipments should not be hidden by equipment wiring.	Yes / No.	
66.	Check availability of 240V single phase 50 HZ, AC socket with switch suitable to accept 5 Amps and !5 Amps pin round standard plug, is provided in the interior of each cubicle with ON-OFF switch for connection of hand lamps.	Yes / No.	
67.	Check that panels are provided with a fluorescent lighting fixture rated with 240 Volts single phase, 50 Hz supply for the interior illumination of the panel during maintenance. The fittings are complete with switch fuse unit and switching of the lighting is controlled by the respective panel door switch. Adequate lighting with fuse unit is also provided for the corridor in control panels.	Yes / No.	
68.	Check control panels are provided with necessary arrangements for receiving, distributing, isolating and	Yes / No.	

SN	Description of Activity	Feedback	Remarks
	fusing of DC and AC supplies for various control, signalling, lighting and space heater circuits. The incoming and sub circuits are separately with switch fuse units.		
69.	Check panels are provided with a space heater rated for 240 V, single phase, 50 Hz, AC supply for the internal heating of the panel to prevent condensation of moisture.	Yes / No.	
70.	Check all panels are equipped with an earth bus securely fixed	Yes / No.	
71.	Check when several panels are mounted adjoining each other, the earth bus is made continuous with necessary connectors and clamps for this purpose.	Yes / No.	
72.	Check provision is made for extending the earth bus bars to adjoining panels on either side.	Yes / No.	
73.	Check provision is made on each bus bar of the end panels for connecting earthing grid.	Yes / No.	
74.	Check all metallic cases of relays, instruments and panel mounted equipment including gland plates are connected to the earth bus by copper wires of specified size.	Yes / No.	
75.	Check the colour code of the earthing wire is green.	Yes / No.	
76.	Check that earthing made with equipment is with Nuts and Bolts i.e. For such connection lugs should be pressed and tightened to the terminals through Nuts and Bolts.	Yes / No.	
77.	Check that no equipment is mounted on the panel doors.	Yes / No.	
78.	Check each switch should bear clear inscription identifying its function.	Yes / No.	
79.	Check those who have sufficient knowledge of steel structural job have been employed in steel structural works only.	Yes / No.	
80.	Check necessary instruction has been communicated by supervisor before start of the day's works to workmen under his control.	Yes / No.	
81.	Storing of equipments is to be made properly to avoid any accident during handling.	Yes / No.	
82.	Check all Nuts and bolts are properly raised or lowered preferably using closed loop pulleys and gully bags / hand bags tied at the end for carrying nuts and bolts.	Yes / No.	
83.	Check that Fire resistant sheets are used before entrance of control cable in control room.	Yes / No.	
84.	Check air compressor tubing properly tightened.	Yes / No.	
85.	Check all carrying connectors / clamps properly tightened.	Yes / No.	

III. CONDUCTOR LAYOUT DURING CONSTRUCTION STAGE :

SN	Description of Activity	Feed back	Remarks
1.	Check all members are fixed in structure and ensure proper size of Nuts and Bolts are rigidly tightened and	Yes / No.	

SN	Description of Activity	Feed back	Remarks
	punching / tacking / tack welding is done in towers / structures before undertaking conductor laying job.		
2.	Ensure proper scaffolding arrangements made during laying of conductor (While Power Line crossing etc).	Yes / No.	
3.	Ensure that all members are fitted in structure before undertaking conductor laying work.	Yes / No.	
4.	Ensure that the discharge rod is electrically tested before use.	Yes / No.	
5.	Ensure whether the structure is properly earthed.	Yes / No.	
6.	Only nylon or polypropylene ropes should be used during conductor laying in vicinity of live overhead lines.	Yes / No.	
7.	Ensure that PTW has been taken from the concerned authority when extension of existing substation is under execution.	Yes / No.	
8.	Ensure that Winch, Pulleys etc. are properly earthed.	Yes / No.	
9.	For LT lines, check whether special persons are posted at each point of isolation till return of permit (PTW) if positioning of person is not possible then it is to be seen that all the point of isolation has been kept in the locked position till the work is in progress.	Yes / No.	
10.	Whether the network of LT lines has been thoroughly checked and precautions taken against inadvertent charging.	Yes / No.	
11.	Check that proper arrangement is made / available for grounding LT lines coming across during conductor laying. (This can be done by way of portable earthing and short circuiting devices which cab be engaged to and disengaged from LT lines, keeping away from the LT lines until all operations on the same are completed and all man and materials are removed from the LT lines).	Yes / No.	
12.	Check the provision and proper positioning for the guying and back staying (Where necessary).	Yes / No.	
13.	Check working of hydraulic crimping machine.	Yes / No.	
14.	Check before and after crimping, dimensional changes in clamps and are in accordance with the drawings and specifications.	Yes / No.	

IV. SWITCHYARD EARTHING DURING CONSTRUCTION STAGE:

SN	Description of Activity	Feed back	Remarks
1.	Check that while earthing conductor crossing the road is laid 300 mm below the road or at greater depth depending upon the site conditions.	Yes / No.	
2.	Check that while laying the Earthing conductor in	Yes / No.	

SN	Description of Activity	Feed back	Remarks
	outside area is buried at least 600 mm below the furnished ground level.		
3.	Check that the earthing pads have been provided for the apparatus / equipments at accessible position.	Yes / No.	
4.	Check all steel columns, metallic stairs are connected to nearby earthing grid conductor by two earthing leads.	Yes / No.	
5.	Check of earthing of lightening fixtures, receptacles switches, junction boxes lighting conduits has been done by a separate earthing conductor.	Yes / No.	
6.	Check that the railway tracks within switchyard area has been earthed at a spacing of 30 Mts. / specified distance and also at both ends.	Yes / No.	
7.	Check cable trays has been connected to earthing flat of 50X6 mm / specified sized earthing flat at intervals specified in approved drawing.	Yes / No.	
8.	Check that this earthed flat is earthed at about 30 Mts. distance.	Yes / No.	
9.	All accessories in transformer and reactor like radiators tank, cooling banks etc are connected to the earthing grid at minimum two points.	Yes / No.	
10.	Check metallic conduits are not used as earth continuity conductor.	Yes / No.	
11.	Check flexible earthing connectors should be provided for the moving parts.	Yes / No.	
12.	Check sheath and armor of single core power cable is earthed at switchgear end and equipment side.	Yes / No.	
13.	Check contact surface of earthing pads for jointing free from scale, paint, enamel, grease, rust or dust.	Yes / No.	
14.	Check that light poles, junction boxes on the poles, cable and cable boxes / glands, lockout switches etc. are connected to the earthing conductor running along with the supply cable which intern is connected to the earthing grid conductor at a minimum two points.	Yes / No.	
15.	Check earthing conductor which is generally buried 2000 mm outside the switchyard fence. All the gates and every alternate post of the fence are to be connected to earthing grid.	Yes / No.	
16.	Check megger used for measuring soil resistivity is calibrated with desired accuracy.	Yes / No.	
17.	The earth resistivity has been measured in dry weather condition.	Yes / No.	
18.	Check the earthing of Transformers and Shunt reactor, earth pits are constructed as per relevant standard / approved drawing.	Yes / No.	
19.	Check that the measured value of combined earth resistance should be less than 1 Ohm.	Yes / No.	
20.	Check that for earth electrode and individual earth pits, this value should not be more than one Ohm.	Yes / No.	
21.	Check all non current carrying metal parts shall be effectively earthed by two separate and distinct earth connections (Indian Electricity Rule 61,67)	Yes / No.	

SN	Description of Activity	Feed back	Remarks
22.	Check that all pylon supports in the Fire Fighting HVSW system has been earthed to the earthmat.	Yes / No.	

V. GENERAL POINTS COMMON FOR ALL ACTIVITIES DURING EXCAVATION, CASTING OF FOUNDATION

Erection of structures, laying of Conductor, storage and transportation of material:

SN	Description of Activity	Feed back	Remarks
1.	Check Supervisors / Workmen have been provided with required healthy PPEs. Like (Safety helmet / Safety Belts / Safety Shoes / Gum Boot etc. as applicable)	Yes / No.	
2.	Check availability of First Aid Box with required medicines at site.	Yes / No.	
3.	Check Site Instruction register is available at site.	Yes / No.	
4.	Ensure Supervisor / Gang Leader always issues instruction to the Workmen including contractor labour before start of work.	Yes / No.	
5.	Ensure supervisory staff from Power Grid is available at site during construction.	Yes / No.	
6.	Check all driver and plant operators are holding valid driving license.	Yes / No.	
7.	Check the vehicle for rescue is available at site.	Yes / No.	
8.	Ensure engaged labour are aware of the job.	Yes / No.	
9.	Ensure supervisor / workmen engaged in the field are aware of First Aid Techniques (Such as in case of Electric Shock, Fall from the height, Snake bite and the person rescued from buried under the debris, rescue of person from drowning etc.	Yes / No.	
10.	Check for availability and to keep a record of nearby Hospital / Doctor in case of emergencies arises.	Yes / No.	
11.	While transporting heavy consignment of conductor / EW drums from central store to site by the use of Cranes, Truck, Tractor. The safety aspect for construction and failure of brake system of moving machinery is to be checked.	Yes / No.	
12.	At least one dry powder type of portable fire extinguisher shall be provided especially where explosive or blasting agents are used for excavation. (If applicable)	Yes / No.	
13.	Check the competence (Qualification / experience) of supervisor / gang leader of contractor.	Yes / No.	
14.	Wire mesh rolls shall be secured in order to prevent dangerous recoiling action.	Yes / No.	
15.	Proper unloading arrangement has been made at site (Preferably with crane) to unload the material.	Yes / No.	

SN	Description of Activity	Feed back	Remarks
16.	After unloading the material visual inspection of the materials has been carried out along with the erection contractor to check that the material has not been damaged or not (Galvanizing is proper or not) As per approved Field Quality Plan etc.	Yes / No.	
17.	While transporting the heavy laden equipment like transformer / Reactor by road from Rly Stn to Sub station check whether for all safety precaution taken. Like safe lifting capacity of crane, safe load on culvert / Bridge / Nala / Drain etc.and working plan is available at site with specific reference to safety e.g. local earthing, skilled & experience manpower, proper T&P, strength and LT wires / HT wires interrupting the height of equipment and the required clearance maintained etc. Permission to be obtained from concerned authority if required. "Impact recorder on the equipment like Reactor / Transformer must be installed during transportation"	Yes / No.	
18.	Check that the adequate and safe means of access and egress has been provided for all work places as far as reasonably practicable and is being used by the workers.	Yes / No.	
19.	Check proper illumination is provided at the work places and their approaches including passage ways.	Yes / No.	
20.	Check that the lamps have been protected by suitable guards where necessary to prevent danger, in case the lamp breaks.	Yes / No.	
21.	Check loose materials which are not required for use shall not be placed or left so as dangerously to obstruct work places or passage ways.	Yes / No.	
22.	Check all projected nails has been removed or bent over to prevent injury.	Yes / No.	
23.	Check scrap, waste and rubbish has not been allowed to accumulate on the site or the scrap materials has been stored at the isolated place.	Yes / No.	
24.	Check that the worker while working at height scaffold materials, waste materials and tools are not being thrown by them to cause injury to any person.	Yes / No.	
25.	Check whether contractor has procured required quantity of PPE considering maximum number of erection gangs deployed at one time. Check the quantity of PPEs.	Yes / No.	
26.	Check that the PPEs required by the workmen are being utilized by them always.	Yes / No.	
27.	Check the worker is under constant surveillance by the other person while working at height.	Yes / No.	
28.	Check construction site has been barricaded for unauthorized persons / animals.	Yes / No.	

SN	Description of Activity	Feed back	Remarks
29.	Check that lifting appliances and machines and vehicles used on the construction site is of sound material and good quality and is free from patent defects and is strong enough to with safely the load and stresses to which they will be subjected.	Yes / No.	
30.	Check structures and equipment is being used only for the purpose for which they were intended.	Yes / No.	
31.	Check equipment has been operated by the competent person.	Yes / No.	
32.	Check portable ladders shall not exceed 9 Mts. in length, other wise may cause danger while climbing of person and back legs shall be equally braced.	Yes / No.	
33.	Check unskilled labour are not utilized for skilled jobs and only experience persons are deployed for erection.	Yes / No.	
34.	Check a well planed and documented procedure for the entire Construction works of Sub station shall be prepared by contractor and get approved from Power Grid for distribution to Contractors' field staff and Power Grid for follow up.	Yes / No.	
35.	Check no metallic measuring tapes are being used during expansion of charged bays.	Yes / No.	
36.	Check metal ladders are not being used in the vicinity of exposed live electrical equipment.	Yes / No.	
37.	Check one bore well is available for water supply in case Municipal Construction supply is not available	Yes / No.	
38.	Check charged area of a yard should be properly fenced off.	Yes / No.	
39.	Check ladders / lengthy articles / lengthy equipments etc. should always be carried in horizontal position.	Yes / No.	
40.	Check insurance by contractor for the labour to provide adequate coverage for any accident etc.	Yes / No.	

Remarks if any:

Signature

Signature

Signature

Name :

Designation:

TSECL Site Representative

Name :

Designation:

Rep. from Contractor

Name :

Designation :

**Rep. from TSECL
Circle office**

ANNEXURE – 8
PUBLIC CONSULATATION BROCHURE



অকশ্বের সংখ্যা

ত্রিপুরা রাজ্য বিদ্যুৎ নিগম লিমিটেড
(ত্রিপুরা সরকার দ্বারা নিয়ন্ত্রিত)

ত্রিপুরা সহ উত্তর-পূর্ব রাজ্যগুলির বিদ্যুৎ ব্যাবস্থার উন্নতির জন্য ভারত সরকার-লিমিটেডের আর্থিক সহায়তায় উত্তর-পূর্ব ক্ষেত্র বিদ্যুৎ ব্যাবস্থার উন্নতিকরণ প্রকল্প (NERPSIP) গঠন করেছেন, যার অংশ হিসেবে বিদ্যুৎ সরবরাহের, গর্তের পরিবর্তন ও বর্ধন গ্রহণ করা হবে। পাশাপাশি বর্তমান সরবরাহের ক্ষমতা বৃদ্ধি ও সম্প্রসারণ করা।

উত্তর-পূর্ব ক্ষেত্র বিদ্যুৎ ব্যাবস্থার উন্নতিকরণ প্রকল্প (NERPSIP) ত্রিপুরা রাজ্যের উন্নতিকরণের ক্ষমতা বৃদ্ধি করা তথা পরিবর্তন ও বর্ধন করার উদ্দেশ্যে।

উত্তর-পূর্ব ক্ষেত্র বিদ্যুৎ ব্যাবস্থার উন্নতিকরণ প্রকল্প (NERPSIP) ত্রিপুরা রাজ্যের উন্নতিকরণের ক্ষমতা বৃদ্ধি করা তথা পরিবর্তন ও বর্ধন করার উদ্দেশ্যে।

আমরা আশা করি উত্তর-পূর্ব ক্ষেত্র বিদ্যুৎ ব্যাবস্থার উন্নতিকরণ প্রকল্প (NERPSIP) অন্য অঞ্চল থেকে আনা বা আশ্রয়িত করা হবে।



PROJECT SUMMARY

TRIPURA STATE ELECTRICITY CORPORATION LTD
(A Government of Tripura Enterprise)

In order to strengthen the power scenario of the North Eastern States including Tripura, the Government of India with the financial assistance of the WORLD BANK, has formulated the North Eastern Region Power System Improvement Project (NERPSIP) which envisages in construction of new power Sub-stations, Transmission & Distribution lines and simultaneously augmentation/expansion of the existing Sub-stations and Transmission lines.

The NERPSIP in the state of Tripura broadly aims at:-

- Load enhancement of the transmission and distribution network of Tripura as well as reducing the transmission and distribution (T & D) loss.
- To adequately address the demand side management for ensuring adequate supply of electricity.

For implementation of project under North Eastern Region Power System Improvement Project (NERPSIP) construction of different 132 kV substation and transmission & distribution line have been planned to be taken up in this area. For construction of transmission line under this project, any damage caused will be compensated as per the Government norms.

We hope that implementation of the North Eastern Power System Improvement Project (NERPSIP) in the state of Tripura will definitely contribute in the socio-economic development of the state.

ANNEXURE – 9
DETAILS OF PUBLIC CONSULTATION

DETAILS OF PUBLIC CONSULTATION MEETING/জন মন্তুনা সভার বিবরণ

Subject/ বিষয়
Construction of 132 kV Udaipur – Bagafa Line ,132kV Bagafa- Satchand Line,132kV Bagafa – Belonia Line & associated distribution lines(with financial assistance of WORLD BANK) under NERPSIP Project NERPSIP প্রকল্পের আওতায় (বিশ্ব ব্যাংকের আর্থিক সহায়তায়) 132kV উদয়পুর- বাগাফা, 132kV বাগাফা - সাতচন্দ ও 132kV বাগাফা - বীলোনিয়া পরিবাহী লাইন এবং সংযুক্ত বন্টন লাইন নির্মাণ
Place of Meeting/সভার স্থান
Bagafa RD Block(BDO Office Conference Hall)/ বাগাফা ব্লক (BDO অফিস কনফারেন্স হল)
Date of Meeting/সভার তারিখ
15.09.2014 / ১৫.০৯.২০১৪
Name of the dignitary present in the meeting/ সভায় উপস্থিত মর্যাদাপূর্ণ ব্যক্তিদের নাম
A. Tripura Government/ ত্রিপুরা সরকার 1) Sh. Himangsu Roy, Sabhaadhipati, Belonia, South Tripura District 2) Sh.Sankar Majumdar, chairman Bagafa Block. 3) Sh. Parikshit Mora Singh, BAC Chairman 4) Sh. Arpan Dutta, Vice-Chairman 5) Sh. Hiralal Debbarma, Sr. DM 6) Sh. Ashish Dutta, BDO, Bagafa
B. TSECL Officials/ TSECL কর্মকর্তারা 1. Sh. Ratan Das, DGM,TSECL
c. POWERGRID Officials/ পাওয়ার গ্রিড কর্মকর্তারা 1. Sh. N. Dube, DGM, POWERGRID 2. Sh. D.N.Brahma, Chief Manager, POWERGRID 3. Sh. Uttam Debnath, Sr. Engineer, POWERGRID
People present in the meeting/ সভায় উপস্থিত জনসাধারণ
200-250 nos. of local village and some common public .(Attendance Sheet Enclosed) 200-250 জন স্থানীয় গ্রাম এবং কিছু সাধারণ পাবলিক (উপস্থিত ব্যক্তিবর্গের সাক্ষর)

Point addressed to the people/ জানা সাধারণের উদ্দেশ্য ভাসন:

A brief of the NORTH EASTERN REGION POWER SYSTEM IMPLEMENTATION PROJECT(NERPSIP) under the world bank assistance has been deliberated at the beginning of the meeting by Sh. Rattan Das, DGM,TSECL. Importance & necessity of the project, necessity for upgradation of existing transmission & distribution network, various environment & Social issues associated with the project have been briefly discussed and appraised to the public present in the meeting.

আলোচনা সভার শুরুতে TSECL এর ডেপুটি জেনারেল ম্যানেজার শ্রী রতন দাস মহাসয় বিশ্ব ব্যাংকের আর্থিক সহায়তায় উত্তর পূর্ব ক্ষেত্র বিদ্যৎ বাবস্থা উন্নতিকরণ প্রকল্প(NERPSIP) সমন্ধে জনসাধারণের উদ্দেশ্যে সংক্ষিপ্ত তথ্য দিলেন । তাছাড়া প্রকল্পের প্রয়োজনীয়তা ও গুরুত্ব, বিদ্যৎ পরিবাহী লাইন এবং বন্টন লাইন এর ক্ষমতা বৃদ্ধির প্রয়োজনীয়তা, প্রকল্পের সঙ্গে যুক্ত বিভিন্ন পরিবেশ ও সামাজিক বিসয়, সমন্ধে সংক্ষিপ্ত জানামল্লানা উথাপন করলেন উপস্থিত জনসাধারণের উদ্দেশ্যে ।

Response from Public/ জানা সাধারণের থেকে প্রতিক্রিয়া

Representatives from the public also responded and raised various concerns about the project. The various issues raised by public are summarised as below:-

- ✓ Whether this line will improve the power supplies in our village and remove frequent interruption/outage
- ✓ Whether these lines are safe for the nearby dwellers without any problems of electrocution while working in the fields
- ✓ What is compensation policy for the standing crops damaged and compensation for the land occupied by the tower footings

জনসাধারণের পক্ষ্য থেকেও প্রতিনিধিরা প্রতিক্রিয়া এবং প্রকল্প সম্পর্কে বিভিন্ন উদ্বেগ উথাপিত করলেন । জনসাধারণ দ্বারা উথাপিত কিছু গুরুত্বপূর্ণ বিষয় নীচের সংক্ষিপ্ত করা হলো :-

- এই প্রকল্প এর জন্য আমাদের গ্রামে বিদ্যৎ সরবরাহ উন্নত হবে কিনা এবং ঘন ঘন বিদ্যুত বিভ্রাট মুছে ফেলা যাবে কিনা ?
- এই লাইন এর জন্য নিকটবর্তী গ্রামবাসীরা তাদের জমিতে কাজ করার সময় তরিতাহত হয়ে কোনো ক্ষতিগ্রস্ত হবে কিনা ?
- ক্ষতিগ্রস্ত ফসলের ক্ষতিপূরণের জন্য ক্ষতিপূরণ নিয়ম কি হবে এবং টাওয়ার বানানোর জন্য যে জমি লাগবে তার ক্ষতিপূরণের কি নিয়ম হবে ?

Conclusion/ উপসংহার

However all the public present have unanimously agreed to the necessity and importance of the project and assured their co-operation during the implementation of the project.

TSECL/POWERGRID has assured that all the genuine issues will be duly taken care of during the implementation of the project. Further

- This transmission line along with associated distribution line planned to be constructed for improvement of electricity supply and minimize the power cut in your village
- Sufficient electrical clearance will be maintained while construction of these line and hence no electrocution while working in the field.
- For damaged crops,trees sufficient compensation will be given as per the rate provided by district revenue authority. Further no land will be acquired while constructing the tower but sufficient surface compensation will be provided.

The meeting has been concluded with a request to all public for their support in completion of the project.

তবে সবশেষে উপস্থিত জনসাধারণ সর্বসম্মতিক্রমে প্রকল্পের প্রয়োজনীয়তা এবং গুরুত্ব নিয়ে একমত প্রকাশ করেছেন এবং প্রকল্প বাস্তবায়ন সময় তাদের সহযোগিতা নিশ্চিত করেছেন ।

TSECL / পাওয়ার গ্রিড কর্মকর্তারা সমস্ত বাস্তব সমস্যা উপর প্রকল্প বাস্তবায়নের সময় যথায়ত নজর দেয়ার আশ্বাস দিয়েছেন. তাছাড়া

- এই বিদ্যৎ পরিবাহী লাইন এবং সংযুক্ত বন্টন লাইন নির্মাণ এর ফলে এই এলাকার বিদ্যৎ বেবস্থার উন্নতি হবে এবং ঘন ঘন বিদ্যৎ কাটা বন্ধ হবে।
- বিদ্যৎ পরিবাহী লাইন এবং বন্টন লাইন নির্মাণের সময় যথেষ্ট বৈদ্যুতিক ব্যবধান রক্ষণাবেক্ষণ করা হবে যাতে বিদ্যৎ পরিবাহী লাইন এবং বন্টন লাইন কাছাকাছি বা নিকটবর্তী মাঠে কাজ করা লোকদের কোনো তারিতাহতর সম্ভাবনা না থাকে।
- ক্ষতিগ্রস্ত ফসলের ও গাছ এর জন্য জেলা রাজস্ব কর্তৃপক্ষ দ্বারা উপলব্ধ হার অনুযায়ী ক্ষতিপূরণ দেওয়া হবে। টাওয়ার বানানোর জন্য কোনো জমি অধিগ্রহণ করা হবে না কিন্তু টাওয়ার বানানোর ফলে যে গাছ বা ফসল ক্ষতি হবে তার ক্ষতি পূরণ দেওয়া হবে

প্রকল্প বাস্তবায়নে জনসাধারণের সহযোগিতার অনরোধের সঙ্গে সভা সমাপ্তির ঘোষণা করা হয়েছে

TRIPURA STATE ELECTRICITY CORPORATION LTD
(A GOVERNMENT OF TRIPURA ENTERPRISE)



Public Consultation Meeting
ATTENDANCE SHEET

Name of Line:- Construction of 132 kV Udaipur - Bagafa Line, 132kV Bagafa- Satchand Line, 132kV Bagafa - Belonia Line & associated distribution lines (with financial assistance of WORLD BANK) under NERPSIP Project

Date- 15.09.2014

Venue- BAGAFA

Sl. no.	Name of the Present Villager	Name of Village/Address	Work/Profession	Sign.
১)	Soma Das	Lowgang	House wife	Soma Das
২)	Jiban Krishna Patra	Lowgang	- do -	J Patra
৩)	সমা দাস	Lowgang	"	সমা দাস
৪)	শ্রী পরচন্দ্র দাস	Lowgang	"	শ্রী পরচন্দ্র দাস
৫)	সুভাষা দেবী	Lowgang	"	সুভাষা দেবী
৬)	সুভাষা দেবী	Subash colony	"	Suvasna sou
৭)	সুভাষা দেবী	"	"	সুভাষা দেবী
৮)	সুভাষা দেবী	Lowgang	"	Mafumod
৯)	সুভাষা দেবী	"	Business	Somhar Das
১০)	সুভাষা দেবী	"	"	Philip deutha
১১)	সুভাষা দেবী	Lowgang	"	Jiban bahin dear 18/9/14

TRIPURA STATE ELECTRICITY CORPORATION LTD
(A GOVERNMENT OF TRIPURA ENTERPRISE)



Public Consultation Meeting
ATTENDANCE SHEET

Name of Line:- Construction of 132 kV Udaipur - Bagafa Line, 132kV Bagafa- Satchand Line, 132kV Bagafa - Belonia Line & associated distribution lines (with financial assistance of WORLD BANK) under NERPSIP Project

Date- 15.09.2014

Venue- BAGAFA

Sl. no.	Name of the Present Villager	Name of Village/Address	Work/Profession	Sign.
12	Rasmohan Chowdhury	Garechhang	Farmer	Rasmohan Chowdhury
13	Anjali Bhowmik	Garechhang	HPW	Anjali Bhowmik
14	Nirmal Tripathy	Garechhang	Farmer	Nirmal Tripathy
15	সত্যজিৎ বসু	সমস্যা	HPW	সত্যজিৎ বসু
16	সুজাতা চন্দ্র	Rak. Gang	Farmer	Sujan Deb Nath
17	অসমীয়া (HPW)	DO -	Alo scini d/nath HPW	Alo scini d/nath
18	অজয় চন্দ্র (HPW)	DO	HPW	Anju Das Deb
19	অজয় চন্দ্র	DO	HPW	Rabin Das
20	অমিতাভ সেন	Betageh	HPW	Tapasi Majumdar
21	অমিতাভ সেন	Betageh	HPW	অমিতাভ সেন

TRIPURA STATE ELECTRICITY CORPORATION LTD
(A GOVERNMENT OF TRIPURA ENTERPRISE)



Public Consultation Meeting
ATTENDANCE SHEET

Name of Line:- Construction of 132 kV Udaipur - Bagafa Line ,132kV Bagafa- Satchand Line,132kV Bagafa - Belonia Line & associated distribution lines(with financial assistance of WORLD BANK) under NERPSIP Project

Date- 15.09.2014

Venue- BAGAFA

Sl. no.	Name of the Present Villager	Name of Village/Address	Work/Profession	Sign.
21	MILAN DAS	LONGAAS	H/W	Milansun
23	মিলন দাস	Betaga	Business	Sohajda Sah
24	মিলন দাস	Betaga	"	Milhan
25	মিলন দাস	Betaga	"	Rinal D
26	মিলন দাস	Betaga	"	Milhan
27	Bimal Ch. Das.	Kanchanagar	"	Bimal Ch Das
28	মিলন দাস (4751)	Kanchan Nagar	H/W	Milhan (4751)
29	মিলন দাস	DO	Business	Milhan
30	Nan' Gopal Bora	DO	Business	Nan' Gopal Bora
31	মিলন দাস	DO	Business	Milhan
32	Topan Das,	Subhreshi Lalay	Business	Topan Das,

TRIPURA STATE ELECTRICITY CORPORATION LTD
(A GOVERNMENT OF TRIPURA ENTERPRISE)



Public Consultation Meeting
ATTENDANCE SHEET

Name of Line:- Construction of 132 kV Udaipur - Bagafa Line ,132kV Bagafa- Satchand Line,132kV Bagafa - Belonia Line & associated distribution lines(with financial assistance of 'WORLD BANK) under NERPSIP Project

Date- 15.09.2014

Venue- BAGAFA

Sl. no.	Name of the Present Villager	Name of Village/Address	Work/Profession	Sign.
33	Sailapati Chakraborty	Kanchannagar	Business	Sailapati Chakraborty
34	Monchai Mog	"	H/W	Monchai Mog
35	Sima Debnath	West Kattalia	"	Sima Debnath
36	Shipra Podder (Dey)	"	"	Shipra Podder (Dey)
37	Janaki Reang	"	"	Janaki Reang
38	Kabir Reang	"	Business	Kabir Reang
39	Bimal Dutta	"	"	Bimal Dutta
40	Sukhes Das	"	"	Sukhes Das
41	Nikhil Mazumdar	"	"	Nikhil Mazumdar
42	Arup Choudhary	"	"	Arup Choudhary
43	Pankaj Nath	Belaga	"	Pankaj Nath

TRIPURA STATE ELECTRICITY CORPORATION LTD
(A GOVERNMENT OF TRIPURA ENTERPRISE)



Public Consultation Meeting
ATTENDENCE SHEET

Name of Line:- Construction of 132 kV Udaipur - Bagafa Line ,132kV Bagafa- Satchand Line,132kV Bagafa - Belonia Line & associated distribution lines(with financial assistance of WORLD BANK) under NERPSIP Project

Date- 15.09.2014

Venue- BAGAFa

Sl. no.	Name of the Present Villager	Name of Village/Address	Work/Profession	Sign.
44	Shefali Rani D/w	Betaga	H/W	<i>[Signature]</i>
45	Swapna Debnath	"	"	Swapna D/w
46	Madhuri Das	"	"	Madhuri Das
47	Sirsha Das	"	"	Sirsha Das
48	Suparna Das	East Bagafa	Panchayat Samiti Member	Suparna Das
49	Neeraj Mog	Garodhang	H/W	Neeraj Mog
50	Milani Das	"	H/W	<i>[Signature]</i>
51	Paiyu Mog	"	Business	<i>[Signature]</i>
52	Sujit Tripura	Garodhang	"	Sujit Tripura
53	Angka Mog	Subhash Colony	"	Angka Mog
54	Parimal Ch. Das	"	"	<i>[Signature]</i>

TRIPURA STATE ELECTRICITY CORPORATION LTD
(A GOVERNMENT OF TRIPURA ENTERPRISE)



Public Consultation Meeting
ATTENDANCE SHEET

Name of Line:- Construction of 132 kV Udaipur - Bagafa Line ,132kV Bagafa- Satchand Line,132kV Bagafa - Belonia Line & associated distribution lines(with financial assistance of WORLD BANK) under NERPSIP Project

Date- 15.09.2014

Venue- BAGAFA

Sl. no.	Name of the Present Villager	Name of Village/Address	Work/Profession	Sign.
55	Prabir Debnath	Betaga	P/S	Prabir Debnath
56	Ranga Mohan	"	Business	Ranga Mohan
57	Raghunath Tripura	"	"	Raghunath Tripura
58	Dhirendra Ranga	"	"	Dhirendra Ranga
59	Sanjay Debnath	R.K Gony	Prodhun	Sanjay Debnath
60	Smiti Nandi	Ranchannagar	Business	Smiti Nandi
61	Ranjati Janalia	Kanu	"	Ranjati Janalia
62	Biswapati D/Barnu	South Takra	"	Biswapati D/Barnu
63	Suksasi D/Barnu	Kajapur	"	Shukeshari Debnath
64	Bangla Mohan Kochia	Takmachau	"	Bangla Mohan Kochia
65	Panchelaxmi Tripura	Gardhang	"	Panchelaxmi Tripura

TRIPURA STATE ELECTRICITY CORPORATION LTD
(A GOVERNMENT OF TRIPURA ENTERPRISE)



Public Consultation Meeting
ATTENDANCE SHEET

Construction of 132 kV Udaipur - Bagafa Line ,132kV
Name of Line:- Bagafa- Satchand Line,132kV Bagafa - Belonia Line &
associated distribution lines(with financial assistance of
WORLD BANK) under NERPSIP Project

Date- 15.09.2014

Venue- BAGAF A

Sl. no.	Name of the Present Villager	Name of Village/Address	Work/Profession	Sign.
66	Malati Tripur	Takmeselu	H/W	Malati Nautia
67	Bishnu Priyanganu (N.H.)	Bedaga	Business	Bishnu priyanganu das (N.H.)
68	Priyabasi Rudrapur	Bedaga	"	প্রিয়বাসী রুদ্রপুর
69	Ajit Das	R.K. Gang	"	অজিত দাস
70	Shyamal Datta	Kanchan Nagar	"	শ্যামল দত্ত
71	Nirapada Sar.	Tripura Aids Control Society	"	Nirapada Sar 15/09/14
72	Suman Das	East Bedaga	"	Suman Das
73	Nanda Pr Das		"	Nanda Pr Das
74				
75				
76				

DETAILS OF PUBLIC CONSULTATION MEETING/জন মন্তুনা সভার বিবরণ

Subject/ বিষয়
Construction of 132 kV Udaipur - Amarpur Line ,132kV Udaipur - Bagafa Line & associated distribution lines(with financial assistance of WORLD BANK) under NERPSIP Project NERPSIP প্রকল্পের আওতায় (বিশ্ব ব্যাংকের আর্থিক সহায়তায়) 132kV উদয়পুর- অমরপুর, 132kV উদয়পুর -বাগাফা পরিবাহী লাইন এবং সংযুক্ত বন্টন লাইন নির্মাণ
Place of Meeting/সভার স্থান
Matabari RD Block(BDO Office Conference Hall)/ মাতাবারী ব্লক (BDO অফিস কনফারেন্স হল)
Date of Meeting/সভার তারিখ
20.09.2014 / ২০.০৯.২০১৪
Name of the dignitary present in the meeting/ সভায় উপস্থিত মর্যাদাপূর্ণ ব্যক্তিদের নাম
A. <u>Tripura Government/ ত্রিপুরা সরকার</u> 1) Smt. Nivedita Bhaumik, BDO 2) Sri Roy Ramkrishna Bhowmik, Chairman 3) Sri Madhusudan Bhowmik, Vice-Chairman 4) Sri Daharam Reang, BAC Chairman
B. <u>TSECL Officials/ TSECL কর্মকর্তারা</u> 1. Sh. Ratan Das, DGM,TSECL
c. <u>POWERGRID Officials/ পাওয়ার গ্রিড কর্মকর্তারা</u> 1. Sh. N. Dube, DGM, POWERGRID 2. Sh. D.N.Brahma, Chief Manager, POWERGRID 3. Sh. Uttam Debnath, Sr. Engineer, POWERGRID
People present in the meeting/ সভায় উপস্থিত জনসাধারণ
150-200 nos. of local village and some common public .(Attendance Sheet Enclosed) 150-200 জন স্থানীয় গ্রাম এবং কিছু সাধারণ পাবলিক (উপস্থিত ব্যক্তিবর্গের সাক্ষর)

Point addressed to the people/ জানা সাধারণের উদ্দেশ্য ভাসন:

A brief of the NORTH EASTERN REGION POWER SYSTEM IMPLEMENTATION PROJECT(NERPSIP) under the world bank assistance has been deliberated at the beginning of the meeting by Sh. Rattan Das, DGM,TSECL. Importance & necessity of the project, necessity for upgradation of existing transmission & distribution network, various environment & Social issues associated with the project have been briefly discussed and appraised to the public present in the meeting.

আলোচনা সভার শুরুতে TSECL এর ডেপুটি জেনারেল ম্যানেজার শ্রী রতন দাস মহাসয় বিশ্ব ব্যাংকের আর্থিক সহায়তায় উত্তর পূর্ব ক্ষেত্র বিদ্যৎ বাবস্থা উন্নতিকরণ প্রকল্প(NERPSIP) সমন্ধে জনসাধারণের উদ্দেশ্যে সংক্ষিপ্ত তথ্য দিলেন । তাছাড়া প্রকল্পের প্রয়োজনীয়তা ও গুরুত্ব, বিদ্যৎ পরিবাহী লাইন এবং বন্টন লাইন এর ক্ষমতা বৃদ্ধির প্রয়োজনীয়তা, প্রকল্পের সঙ্গে যুক্ত বিভিন্ন পরিবেশ ও সামাজিক বিসয়, সমন্ধে সংক্ষিপ্ত জানামল্লানা উত্থাপন করলেন উপস্থিত জনসাধারণের উদ্দেশ্যে ।

Response from Public/ জানা সাধারণের থেকে প্রতিক্রিয়া

Representatives from the public also responded and raised various concerns about the project. The various issues raised by public are summarised as below:-

- ❖ What is compensation policy for the standing crops damaged and compensation for the land occupied by the tower footings
- ❖ What about employment for local people and procedure for same
- ❖ What is the width of ROW for cutting trees? How much compensation for the trees will be given and when.

জনসাধারণের পক্ষ্য থেকেও প্রতিনিধিরা প্রতিক্রিয়া এবং প্রকল্প সম্পর্কে বিভিন্ন উদ্বেগ উত্থাপিত করলেন । জনসাধারণ দ্বারা উত্থাপিত কিছু গুরুত্বপূর্ণ বিষয় নীচের সংক্ষিপ্ত করা হলো :-

- ❖ ক্ষতিগ্রস্ত ফসলের ক্ষতিপূরণের জন্য ক্ষতিপূরণ নিয়ম কি হবে এবং টাওয়ার বানানোর জন্য যে জমি লাগবে তার ক্ষতিপূরণের কি নিয়ম হবে ?
- ❖ এই প্রকল্পের জন্য স্থানীয় মানুষ এর কর্মসংস্থান এবং নিয়োগ নীতির কি নিয়ম হবে ?
- ❖ লাইন বানানোর সময় গাছ কাটার করিডোর/প্রস্থ কি হবে ? কখন এবং কি পরিমাণ ক্ষতিপূরণ দেওয়া হবে গাছের জন্য ?

Conclusion/ উপসংহার

However all the public present have unanimously agreed to the necessity and importance of the project and assured their co-operation during the implementation of the project.

TSECL/POWERGRID has assured that all the genuine issues will be duly taken care of during the implementation of the project. Furthermore

- ❖ For damaged crops,trees sufficient compensation will be given as per the rate provided by district revenue authority. Further no land will be accrued while constructing the tower but sufficient surface compensation will be provided.
- ❖ Local people will be engaged during the construction of line and the engagement will be as per their skill.
- ❖ The width of ROW of cutting trees will be 27 M and sufficient compensation will be given as per the rate provided by district revenue authority during the construction.

The meeting has been concluded with a request to all public for their support in completion of the project.

তবে সবশেষে উপস্থিত জনসাধারণ সর্বসম্মতিক্রমে প্রকল্পের প্রয়োজনীয়তা এবং গুরুত্ব নিয়ে একমত প্রকাশ করেছেন এবং প্রকল্প বাস্তবায়ন সময় তাদের সহযোগিতা নিশ্চিত করেছেন ।

TSECL / পাওয়ার গ্রিড কর্মকর্তারা সমস্ত বাস্তব সমস্যা উপর প্রকল্প বাস্তবায়নের সময় যথাযত নজর দেয়ার আশ্বাস দিয়েছেন. জনসাধারণের প্রশ্নের উত্তরে POWERGRID/TSECL কর্মকর্তারা বলেন

- ❖ ক্ষতিগ্রস্ত ফসলের ও গাছ এর জন্য জেলা রাজস্ব কর্তৃপক্ষ দ্বারা উপলব্ধ হার অনুযায়ী ক্ষতিপূরণ দেওয়া হবে । টাওয়ার বানানোর জন্য কোনো জমি অধিগ্রহণ করা হবে না কিন্তু টাওয়ার বানানোর ফলে যে গাছ বা ফসল ক্ষতি হবে তার ক্ষতি পূরণ দেওয়া হবে
- ❖ প্রকল্পের কাজের রূপায়নের সময় গ্রামের তথা স্থানীয় কারিগর/ শ্রমিক দের তাদের যুগ্যতা অনুযায়ী নিয়োগ করা হবে
- ❖ লাইন বানানোর সময় গাছ কাটার প্রস্থ হবে ২৭ মিটার এবং ক্ষতিগ্রস্ত গাছ এর জন্য জেলা রাজস্ব কর্তৃপক্ষ দ্বারা উপলব্ধ হার অনুযায়ী ক্ষতিপূরণ দেওয়া হবে ।

প্রকল্প বাস্তবায়নে জনসাধারণের সহযোগিতার অনুরোধের সঙ্গে সভা সমাপ্তির ঘোষণা করা হয়েছে

TRIPURA STATE ELECTRICITY CORPORATION LTD
(A GOVERNMENT OF TRIPURA ENTERPRISE)



Public Consultation Meeting
ATTENDENCE SHEET

Name of Line:- Bagafa Line & associated distribution lines (with financial assistance of WORLD BANK) under NERPSIP Project

Date:- 10.09.2014

Venue- MATABARI

Sl. no.	Name of the Present Villager	Name of Village/Address	Work/Profession	Sign.
1	Chameli Das	Pitra	H/W	Chameli Das
2	Malati Nandi	Pitra	H/W	Malati Nandi
3	Kajal Kani Das	Rajnagar	H/W	Kajal Kani Das
4	Jabbar Miya	Rajnagar	Business	Jabbar Miya
5	Haran chandra Das	Putamati	Teacher	Haran ch. Das.
6	Selinara Begam	Putamati	upa Pradhan	Selinara Begam
7	Putul Dey	Putamati	H/W	Putul Dey
8	Nanda Lal Adhikari	Putamati	Panchayat member	Nanda Lal Adhikari
9	Manju Dey	Kilpara	H/W	Manju Dey
10	Purnima Chakraborty	Kilpara	H/W	Purnima Chakraborty
11	Haran ch. Paul	Lakshmi pati	Farmer	Haran ch. Paul
12	Milan Sarkar	Putamati	Business	Milan Sarkar

TRIPURA STATE ELECTRICITY CORPORATION LTD
(A GOVERNMENT OF TRIPURA ENTERPRISE)



Public Consultation Meeting
ATTENDANCE SHEET

Name of Line:- Construction of 132 kV Udaipur - Amarpur Line ,132kV Udaipur - Bagafa Line & associated distribution lines(with financial assistance of WORLD BANK) under NERPSIP Project

Date- 20.09.2014

Venue- MATABARI

Sl. no.	Name of the Present Villager	Name of Village/Address	Work/Profession	Sign.
13	Sajal Paul	Purba Kunjaban	business	Sajal Paul
14	Setal Ch. Sarkar Das.	Purba Kunjaban.	Farmer.	Setal Ch. Sarkar Das.
15	Depali Das	Purba Kunjaban	H/W	Depali Das
16	Bachula trani Debbarma	Purba Kunjaban.	H/W	Bachula trani Debbarma
17	Apu Shil	Uttar Chandrapur	H/W	Apu Shil
18	Chaya Rani Das .	Matabari	H/W	Chaya Rani Das.
19	Pratap chakraborty	- DO -	business	Pratap Chakraborty
20	Sukumar Debbarth	Petra		Sukumar Debbarth
21	Supara Das	- DO -		Supara Das
22	Anil Das	U. Chandrapur	Pradhan	Anil Kumar Das
23	Mithu Das Laskar	1)		Mithu Das (Laskar)
24	Kalpana Majumdar			Kalpana Majumdar

TRIPURA STATE ELECTRICITY CORPORATION LTD
(A GOVERNMENT OF TRIPURA ENTERPRISE)



**Public Consultation Meeting
ATTENDANCE SHEET**

Construction of 132 kV Udaipur - Amarpur Line ,132kV Udaipur -
Name of Line:- Bagafa Line & associated distribution lines(with financial
assistance of WORLD BANK) under NERPSIP Project

Date- 20.09.2014

Venue- MATABARI

Sl. no.	Name of the Present Villager	Name of Village/Address	Work/Profession	Sign.
25	Sepali Das .	w. Kunjaban		
26	Sepali Das .	- Do -		
27	Relu Das	- Do -		
28	Purabi Saha	- Do .		
29	Manika Majumdar. (Sarkar).	Matabari		
30	Archana Debnath	- Do -		
31	Sahalan Niya Sarkar	Uttar Maharan	Member	
32	Kalipa Kathan	- Do .		
33	Skyamal Majumdar	Portamati	proad.lem.	
34	Ratna Majumdar .	v. Matabari		
35	Manidar Begam	w. Kelpara		
36	Kanu Acha .	w. Do -		

TRIPURA STATE ELECTRICITY CORPORATION LTD
(A GOVERNMENT OF TRIPURA ENTERPRISE)



Public Consultation Meeting
ATTENDANCE SHEET

Construction of 132 kV Udaipur - Amarpur Line ,132kV Udaipur
Name of Line:- - Bagafa Line & associated distribution lines(with financial
assistance of WORLD BANK) under NERPSIP Project

Venue- MATABARI

Date- 26.09.2014

Sl. no.	Name of the Present Villager	Name of Village/Address	Work/Profession	Sign.
37	Habit Mijan.	W. Kelpara.	member.	
38	Sabita Mams	Matabari bno.		
39	Kela Sarkar Das	Ful Keemari		Khelasarkar (Das).
40	Sujan Day.	Matabari.		
41	Lakshmi Chakraborty	S- Do-		Laxmi Chakraborty
42	Praan Krishna Das.	S- do.		
43	Abhisit Datta.			Abhisit Datta.
44	Mithurani Das.	Rajnagar		Mithurani Das
45	Anima Das.	- Do -		Anima Das
46	Mime Rani Das. Babu	- Do -		Mime Rani Das (B)
47	Gouri Rani Singh.	Maharani		Gouri Rani Si
48	Lakshmi Das.	- Do -		Laxmi Das

TRIPURA STATE ELECTRICITY CORPORATION LTD
(A GOVERNMENT OF TRIPURA ENTERPRISE)



Public Consultation Meeting
ATTENDANCE SHEET

Construction of 132 kV Udaipur - Amarpur Line ,132kV Udaipur -
Name of Line:- Bagafa Line & associated distribution lines(with financial
assistance of WORLD BANK) under NERPSIP Project

Date- 20.09.2014

Venue- MATABARI

Sl. no.	Name of the Present Villager	Name of Village/Address	Work/Profession	Sign.
49	Prabal Ghosh	Matarani		Babur Chandra Ghosh
50	Dulal Majumdar	- DO -		Subash Sharma
51	Sabiya Bibi	- DO -		Subash Sharma
52	Nareesh Chakraborty	- DO -		Nareesh Chakraborty
53	Hemangshu Das	- DO -		Subash Sharma
54	Sefali Datta	Kelpara		Sabale Datto
55	Chinda Hazari Das	Matabari		Chinda Hazari Das
56	Runu Nag	Pul Kumari		Runu Nag
57	Goparani Das	- DO -		Gopani Das (Sarkar)
58	Durazani Dey	- DO -		Subash Sharma
59	Pabitra Majumdar	- DO -		Subash Sharma
60	Subash Sharma	S. Matabari		Subash Sharma

TRIPURA STATE ELECTRICITY CORPORATION LTD
(A GOVERNMENT OF TRIPURA ENTERPRISE)



Public Consultation Meeting
ATTENDANCE SHEET

Construction of 132 kV Udaipur - Amarpur Line, 132kV Udaipur
Name of Line:- Bagafa Line & associated distribution lines(with financial
assistance of WORLD BANK) under NERPSIP Project

Venue- MATABARI

Date- 20.09.2014

Sl. no.	Name of the Present Villager	Name of Village/Address	Work/Profession	Sign.
64	Pradip Sil	Uttar Chandrapur		Pradip Sil
65	Dulali Dey Deb	"		Dulali Dey (Deb)
66	Dipali Benik Das	"		Dipali Benik Das
67	Rafik Mia	"		Rafik Mia
68	Swapan Ch. Majumdar	Pitara		Swapan Ch. Majumdar
69	Narresh Ch. Das	- Do -		Narresh Ch. Das
70	Biswajit Bhownik	Laxmipati		Biswajit Bhownik
71	Abul Basar	Uttar Maharani		Abul Basar
72	Robindra Km Das	- Do -		Robindra Km Das
73	Abdul Hanif	- Do -		Abdul Hanif
74	Rutik Malik	- Do -		Rutik Malik
75	Jharna Debnath	"		Jharna Debnath

TRIPURA STATE ELECTRICITY CORPORATION LTD
(A GOVERNMENT OF TRIPURA ENTERPRISE)



Public Consultation Meeting
ATTENDANCE SHEET

Construction of 132 kV Udaipur - Amarpur Line ,132kV
Name of Line:- Udaipur - Bagafa Line & associated distribution lines(with
financial assistance of WORLD BANK) under NERPSIP Project

Date- 20.04.2014

Venue- MATABARI

Sl. no.	Name of the Present Villager	Name of Village/Address	Work/Profession	Sign.
76	Prana Rani Dhaty	Uttara Mahasani		Prana Rani Dhaty
77	Shipra Datta	Uttara Mahasani		Shipra Datta
78	Inam Uddin	Kulpara		Inam Uddin
79	Uma Sankar Ghosh	"		Umasankar Ghosh
80	Sohan Mia	"		Sohan Mia
81	Nepal Ch Das	Pitara		Nepal Ch Das
82	Mamtaj Begam	- 00 -		Mamtaj Begam
83	Pran Krishna Das	Matabari		Pran Krishna Das
84	Ashenjita Kar Sankar	Rajnagar		Ashenjita K. Sankar
85	Swarna Bhattacharya	"		Swarna Bhatt Chatterjee
86	Sabitri Chakraborty	Laxmibati		Sabitri Chakraborty
87	Sabita Das	"		Sabita Das

TRIPURA STATE ELECTRICITY CORPORATION LTD
(A GOVERNMENT OF TRIPURA ENTERPRISE)



Public Consultation Meeting
ATTENDENCE SHEET

Construction of 132 kV Udaipur - Amarpur Line ,132kV Udaipur
Name of Line:- - Bagafa Line & associated distribution lines(with financial assistance of WORLD BANK) under NERPSIP Project

Date- 20.09.2014

Venue- MATABARI

Sl. no.	Name of the Present Villager	Name of Village/Address	Work/Profession	Sign.
88	Sukla Rani Yugi	Laxmibati		
89	Rina Sarkar.	Maharaw		
90	Sadhana Das	"		
91	Roy Satyajit Bhowmik	"		
92	Akkase Miah	"		
93	Jatan Ch. Bhowmik	"		
94	Biswabandhu Datta	South Matabari		
95	Dipak Roy	Pitra		
96	Kuntal Das	South Matabari		
97	Ranjit Choudhary	Pitra		
98	Bi plab Dey	Daxsin Matabari		
99	Giribala Das	Matabari		

TRIPURA STATE ELECTRICITY CORPORATION LTD
(A GOVERNMENT OF TRIPURA ENTERPRISE)



Public Consultation Meeting
ATTENDANCE SHEET

Construction of 132 kV Udaipur - Amarpur Line, 132kV
Name of Line:- Udaipur - Bagafa Line & associated distribution lines (with financial assistance of WORLD BANK) under NERPSIP Project

Date- 20.09.2014

Venue- MATABARI

Sl. no.	Name of the Present Villager	Name of Village/Address	Work/Profession	Sign.
100	Affana Das (Deb)	Matabari		ৱাৰী ৩১ অৱি ১৭ অৱি ০৭
107	Shefali Datta	Khilpara		Shefali Datta
102	Jadulal Das	Matabari		২০ অৱি ১৭ ০৭
103	Sukhlal Das (Bank)	Rajnagar.	P-Samiti Member	Sukhlal Das (Bank)
104	Litan Kanti Sen	Kunjaban		Litan Kanti Sen
105	Sujit Das	- DO -		Sujit Das
106	Tohal Palaeer	Paschim Khilpara	Member	Tohal Palaeer
102	Subash Karmakar	Kunjaban		Subash Karmakar
108	Aba Dey	ful Kumari		Aba Dey
109	Simananda Das	W. Khilpara		Simananda Das
110	Mohidul	W. Khilpara Samiti		Mohidul
111	Ratna Rani Sutradhar	- E. Kunjaban		Ratna Rani Sutradhar

১১

DETAILS OF PUBLIC CONSULTATION MEETING/জন মন্তুনা সভার বিবরণ

Subject/ বিষয়
Construction of 132kV Bagafa- Satchand Line,132kV Belonia - Sabroom Line & associated distribution lines(with financial assistance of WORLD BANK) under NERPSIP Project NERPSIP প্রকল্পের আওতায়(বিশ্ব ব্যাংকের আর্থিক সহায়তায়) 132kV বাগাফা - সাতচান্দ ও 132kV বীলোনিয়া - সারুম পরিবাহী লাইন এবং সংযুক্ত বন্টন লাইন নির্মাণ
Place of Meeting/সভার স্থান
Satchand RD Block(BDO Office Conference Hall)/ সাতচান্দ ব্লক (BDO অফিস কনফারেন্স হল)
Date of Meeting/সভার তারিখ
26.09.2014 / ২৬.০৯.২০১৪
Name of the dignitary present in the meeting/ সভায় উপস্থিত মর্যাদাপূর্ণ ব্যক্তিদের নাম
A. Tripura Government/ ত্রিপুরা সরকার 1) Sh. Himangsu Roy, Sabhaadhipati, Belonia, South Tripura District 2) Sh. Hiralal Debbarma, Sr. DM 3) Sh. Goutam Chakraborty, BDO, Satchand
B. TSECL Officials/ TSECL কর্মকর্তারা 1. Sh. Ratan Das, DGM,TSECL
c. POWERGRID Officials/ পাওয়ার গ্রিড কর্মকর্তারা 1. Sh. N. Dube, DGM, POWERGRID 2. Sh. Anupam Acharya, Engineer, POWERGRID
People present in the meeting/ সভায় উপস্থিত জনসাধারণ
150-200 nos. of local village and some common public .(Attendance Sheet Enclosed) 150-200 জন স্থানীয় গ্রাম এবং কিছু সাধারণ পাবলিক (উপস্থিত ব্যক্তিবর্গের সাক্ষর)

Point addressed to the people/ জানা সাধারণের উদ্দেশ্য ভাসন:

A brief of the NORTH EASTERN REGION POWER SYSTEM IMPLEMENTATION PROJECT(NERPSIP) under the world bank assistance has been deliberated at the beginning of the meeting by Sh. Rattan Das, DGM,TSECL. Importance & necessity of the project, necessity for upgradation of existing transmission & distribution network, various environment & Social issues associated with the project have been briefly discussed and appraised to the public present in the meeting.

আলোচনা সভার শুরুতে TSECL এর ডেপুটি জেনারেল ম্যানেজার শ্রী রতন দাস মহাসয় বিশ্ব ব্যাংকের আর্থিক সহায়তায় উত্তর পূর্ব ক্ষেত্র বিদ্যুৎ বাবস্থা উন্নতিকরণ প্রকল্প(NERPSIP) সমন্ধে জনসাধারণের উদ্দেশ্যে সংক্ষিপ্ত তথ্য দিলেন। তাছাড়া প্রকল্পের প্রয়োজনীয়তা ও গুরুত্ব, বিদ্যুৎ পরিবাহী লাইন এবং বন্টন লাইন এর ক্ষমতা বৃদ্ধির প্রয়োজনীয়তা, প্রকল্পের সঙ্গে যুক্ত বিভিন্ন পরিবেশ ও সামাজিক বিসয়, সমন্ধে সংক্ষিপ্ত জানামল্লানা উত্থাপন করলেন উপস্থিত জনসাধারণের উদ্দেশ্যে।

Response from Public/ জানা সাধারণের থেকে প্রতিক্রিয়া

Representatives from the public also responded and raised various concerns about the project. The various issues raised by public are summarised as below:-

- ✚ Whether this line will improve the power supplies in our village and remove frequent interruption/outage?
- ✚ Whether these lines are safe for the nearby dwellers without any problems of electrocution while working in the fields?
- ✚ What is compensation policy for the standing crops damaged and compensation for the land occupied by the tower footings?
- ✚ What about employment for local people and procedure for same ?

জনসাধারণের পক্ষ্য থেকেও প্রতিনিধিরা প্রতিক্রিয়া এবং প্রকল্প সম্পর্কে বিভিন্ন উদ্বেগ উত্থাপিত করলেন। জনসাধারণ দ্বারা উত্থাপিত কিছু গুরুত্বপূর্ণ বিষয় নীচের সংক্ষিপ্ত করা হলো :-

- ✚ এই প্রকল্প এর জন্য আমাদের গ্রামে বিদ্যুৎ সরবরাহ উন্নত হবে কিনা এবং ঘন ঘন বিদ্যুত বিভ্রাট মুছে ফেলা যাবে কিনা ?
- ✚ এই লাইন এর জন্য নিকটবর্তী গ্রামবাসীরা তাদের জমিতে কাজ করার সময় তরিতাহত হয়ে কোনো ক্ষতিগ্রস্ত হবে কিনা ?
- ✚ ক্ষতিগ্রস্ত ফসলের ক্ষতিপূরণের জন্য ক্ষতিপূরণ নিয়ম কি হবে এবং টাওয়ার বানানোর জন্য যে জমি লাগবে তার ক্ষতিপূরণের কি নিয়ম হবে ?
- ✚ এই প্রকল্পের জন্য স্থানীয় মানুষ এর কর্মসংস্থান এবং নিয়োগ নীতির কি নিয়ম হবে ?

Conclusion/ উপসংহার

However all the public present have unanimously agreed to the necessity and importance of the project and assured their co-operation during the implementation of the project.

TSECL/POWERGRID has assured that all the genuine issues will be duly taken care of during the implementation of the project.

- ✚ This transmission line along with associated distribution line planned to be constructed for improvement of electricity supply and minimize the power cut in your village
- ✚ Sufficient electrical clearance will be maintained while construction of these line and hence no electrocution while working in the field.
- ✚ For damaged crops,trees sufficient compensation will be given as per the rate provided by district revenue authority. Further no land will be accrued while constructing the tower but sufficient surface compensation will be provided.
- ✚ Local people will be engaged during the construction of line and the engagement will be as per their skill.

The meeting has been concluded with a request to all public for their support in completion of the project.

তবে সবশেষে উপস্থিত জনসাধারণ সর্বসম্মতিক্রমে প্রকল্পের প্রয়োজনীয়তা এবং গুরুত্ব নিয়ে একমত প্রকাশ করেছেন এবং প্রকল্প বাস্তবায়ন সময় তাদের সহযোগিতা নিশ্চিত করেছেন ।

TSECL / পাওয়ার গ্রিড কর্মকর্তারা সমস্ত বাস্তব সমস্যা উপর প্রকল্প বাস্তবায়নের সময় যথাযত নজর দেয়ার আশ্বাস দিয়েছেন। জনসাধারণের প্রশ্নের উত্তরে POWERGRID/TSECL কর্মকর্তারা বলেন,

- ✚ এই বিদ্যৎ পরিবাহী লাইন এবং সংযুক্ত বন্টন লাইন নির্মাণ এর ফলে এই এলাকার বিদ্যৎ বেবস্বার উন্নতি হবে এবং ঘন ঘন বিদ্যৎ কাটা বন্ধ হবে।
- ✚ বিদ্যৎ পরিবাহী লাইন এবং বন্টন লাইন নির্মাণের সময় যথেষ্ট বৈদ্যুতিক ব্যবধান রক্ষণাবেক্ষণ করা হবে যাতে বিদ্যৎ পরিবাহী লাইন এবং বন্টন লাইন কাছাকাছি বা নিকটবর্তী মাঠে কাজ করা লোকদের কোনো তারিতাহতর সম্ভাবনা না থাকে ।
- ✚ ক্ষতিগ্রস্ত ফসলের ও গাছ এর জন্য জেলা রাজস্ব কর্তৃপক্ষ দ্বারা উপলব্ধ হার অনুযায়ী ক্ষতিপূরণ দেওয়া হবে । টাওয়ার বানানোর জন্য কোনো জমি অধিগ্রহণ করা হবে না কিন্তু টাওয়ার বানানোর ফলে যে গাছ বা ফসল ক্ষতি হবে তার ক্ষতি পূরণ দেওয়া হবে
- ✚ প্রকল্পের কাজের রূপায়ানের সময় গ্রামের তথা স্থানীয় কারিগর/ শ্রমিক দের তাদের যুগ্যতা অনুযায়ী নিয়োগ করা হবে ।

প্রকল্প বাস্তবায়নে জনসাধারণের সহযোগিতার অনুরোধের সঙ্গে সভা সমাপ্তির ঘোষণা করা হয়েছে

TRIPURA STATE ELECTRICITY CORPORATION LTD
(A GOVERNMENT OF TRIPURA ENTERPRISE)



Public Consultation Meeting
ATTENDANCE SHEET

Name of Line: Construction of 132kV Bagafa- Satchand Line, 132kV Belonia - Sabroom Line & associated distribution lines

Venue- SATCHAND

Date- 26.09.2014

Sl. no.	Name of the Present Villager	Name of Village/Address	Work/Profession	Sign.
1	Browni Pal	Theikun	Member	
2	Smt. Muniti Tripura	Uttasghorak	Member	Monuti Tripura
3	Smt. Swapna Das	Dakshin, Chotaloli	Member	স্বপ্না দাস
4	Smt. Kanchanmala Tripura	Kalachara	Member	Kanchan Tripura
5	Smt. Kalita Das	Nahagram	member	কলিতা দাস
6	Smt. Khokan Ray	Kalachara	Upa-Pradhan	Khokan Ray
7	Smt. Ganesh Ch. Ray	- do -	member	Ganesh Ch. Ray
8	Smt. Nibedita Nandi Bhowmik	Purba Harina	Pradhan	Nibedita Nandi (Bhowmik)
9	Smt. Usha Rani Ray	Purba Harina, Kula Salepa	member	উষা রানী রায়
10	Smt. Santibala Ghil	Purba Harina	Member	সন্তিলা গিল
11	Smt. Ratna Debnath	- do -	- do -	রত্না দেবনাথ
12	Smt. Kamal Krishna Debnath	- do -	- do -	Kamal Krishna Debnath

TRIPURA STATE ELECTRICITY CORPORATION LTD
(A GOVERNMENT OF TRIPURA ENTERPRISE)



Public Consultation Meeting
ATTENDANCE SHEET

Name of Line:- Construction of 132kV Bagafa- Satchand Line, 132kV Belonia - Sabroom Line & associated distribution lines

Venue- SATCHAND

Date- 26.09.2014

Sl. no.	Name of the Present Villager	Name of Village/Address	Work/Profession	Sign.
13	Sri Dulal Das	Purba Harin	Member	Dulal Das
14	Sri Shironjyoti Ch. Tripathi	Satchand	Member	শিরঞ্জয় চন্দ্র ত্রিপাঠী
15	Sri Kiritish Ch. Pal	Manuharar	Member	কিরিষ্ণু চন্দ্র পাল
16	Smt. Jharna Das (Name)	- do -	Member	Jharna Das (Name)
17	Smt. Swarna Das	- do -	- do -	Swarna Das
18	Smt. Bapi Majumdar	Battala	- do -	Boppi Majumdar
19	Smt. Lipika Das Majumdar	- do -	- do -	Lipika Das (Majumdar)
20	Smt. Laxmi Banik	Manuharar	- do -	Laxmi Banik
21	Sri Shymal Choudhury	- do -	- do -	শ্যামল চৌধুরী
22	Smt. Shipra Paul	- do -	- do -	Shipra Paul
23	Smt. Sarawati Karmakar	- do -	- do -	সার্বতী কর্মকার
24	" Ranjan Mala Tripura	Bojjoynagar	- do -	Ranjan mala Trm

TRIPURA STATE ELECTRICITY CORPORATION LTD
(A GOVERNMENT OF TRIPURA ENTERPRISE)



Public Consultation Meeting
ATTENDANCE SHEET

Name of Line:- Construction of 132kV Bagafa- Satchand Line, 132kV Belonia - Sabroom Line & associated distribution lines

Date- 26.09.2014

Venue- SATCHAND

Sl. no.	Name of the Present Villager	Name of Village/Address	Work/Profession	Sign.
25	Sh. Jahan Lal D/Nath	South Goratala	Member =	
26	Smt. Manika Das.	Satchand	Chair person.	
27	Sh. Rama Kishore Tripura	Foot chair	Chairman	Rama Kishore Tripura
28	Smt. Mandhira Sarkar	Manguchara.	Member	Mandhira Sarkar
29	" Pratima Das Saha.	Manu Nagar.	- Do -	Pratima Das Saha
30	Sh. Subrata Majumdar	Manughat (Indiranagar).	- Do -	Subrata Majumdar
31	" Ganesh Ch. Debnath	Indiranagar	- Do -	Ganesh Ch. Debnath
32	Smt. Praba Datta Majumdar.	- Do -	- Do -	Prabha Datta Majumdar
33	" Rajal Majumdar	- Do -	- Do -	Rajal Majumdar
34	" Shipra Das	- Do -	- Do -	Shipra Das

TRIPURA STATE ELECTRICITY CORPORATION LTD
(A GOVERNMENT OF TRIPURA ENTERPRISE)



Public Consultation Meeting
ATTENDANCE SHEET

Name of Line:- Construction of 132kV Bagafa- Satchand Line, 132kV Belonia - Sabroom Line & associated distribution lines

Date- 26.09.2014

Venue- SATCHAND

Sl. no.	Name of the Present Villager	Name of Village/Address	Work/Profession	Sign.
35	Smt- Shipra Das Patuani	Chalita Chari. ADC. Village.	Pradhan	Shipra Das Patuani
36	" Suparna Paul Majumdar	W. Harina.	Member.	Suparna Paul (Majumdar)
37	" Namita Sarkar. (As)	- Do -	Pradhan	Namita Sarkar (As)
38	" Neichai Mag.	Kalapani	Pradhan	Neichai Mag
39	" Mimi Mag.	- Do -	Member.	মিমা মগ
40	Sh. Apra Mag	- Do -	- Do -	Apra Mag
41	Smt - Jarna Sarkar.	- Do -	- Do -	Jarna Sarkar
42	" Archana Sarkar.	Nabagan.	Pradhan.	Archana Sarkar
43	" Gita Sarkar.	- Do -	Member	গীতা সর্কার
44	Sh. Manindra Das.	- Do -	- Do -	Manindra Das
45	" Bimal Das	Satchand.	- Do -	Bimal Das
46	" Dinesh Das.	N. Gokulali Das Para.	- Do -	Dinesh Das

TRIPURA STATE ELECTRICITY CORPORATION LTD
(A GOVERNMENT OF TRIPURA ENTERPRISE)



Public Consultation Meeting
ATTENDANCE SHEET

Name of Line:- Construction of 132kV Bagafa- Satchand Line, 132kV Belonia - Sabroom Line & associated distribution lines

Date- 26.09.2014

Venue- SATCHAND

Sl. no.	Name of the Present Villager	Name of Village/Address	Work/Profession	Sign.
47	Sh. Anup choudhury	Kalapauri	Member	Anup Choudhury
48	Smt - Lipi Roy Das	B.K. Pally Panchajet.	Upa Pradhan	Lipi Roy (Das)
49	Sh - Atun Paul	Nabagram	- DO -	Atun Paul
50	" Krishna Batta	Satchand	Member.	Krishna Batta
51	Smt - Jayapati Tripura	- DO -	- DO -	Jayapati
52	" Rajal Rani Das	Nabagram.	- DO -	Rajal Rani Das
53	" Mrachandra (Choudhury) Das	Satchand	- DO -	Mrachandra Das Choudhury
54	Sh. Prabha Ran Tripura	- DO -	- DO -	Prabha Ran Tripura
55	Smt - Satisang Tripura	Sendeupatar ADC.	Chair Person.	Satisang Tripura
56	Sh. Tejha Ran Das	Kalabhara.	Member	Tejha Ran Das
57	" Biswanath Ray	Nabagram.	- DO -	Biswanath Ray
58	" Depak Banik	Manu Bazar	Member -	Depak Banik

TRIPURA STATE ELECTRICITY CORPORATION LTD
(A GOVERNMENT OF TRIPURA ENTERPRISE)



Public Consultation Meeting
ATTENDENCE SHEET

Name of Line:- Construction of 132kV Bagafa- Satchand Line, 132kV Belonia
- Sabroom Line & associated distribution lines

Date- 26.09.2014

Venue- SATCHAND

Sl. no.	Name of the Present Villager	Name of Village/Address	Work/Profession	Sign.
59	Sh. Raj Kumar Das .	Thaeban .	Pradhan .	Raj Kumar Das
60	Smt. Radha Deb Nath .	- Do -	Member	Radha Deb Nath
61	" Gouri Paul	- Do -	- Do -	Gouri Pal.
62	" Sabita Nams .	Dambana .	- Do -	Sabita namsa Sen
63	" Mani Das .	Thaeban .	- Do -	Mani Das
64	Sh. Ratna Sarkar	Nabagan .	- Do -	Ratna Sarkar
65	Smt. Lalita Das .	- Do -	- Do -	Lalita Das
66	" Archana Debnath	Goratali	- Do -	Archana Debnath
67	" Phol Kali	- Do -	- Do -	Fulkali Tripura
68	" Jyotsna Debnath	Kalapani	- Do -	Jyotsna Debnath
69	sh. Sanjit Das	Burba Hareina	- Do -	Sanjit Das
70	" Parimal Patra	N. Goratali	- Do -	Parimal Patra

TRIPURA STATE ELECTRICITY CORPORATION LTD
(A GOVERNMENT OF TRIPURA ENTERPRISE)



Public Consultation Meeting
ATTENDANCE SHEET

Name of Line:- Construction of 132kV Bagafa- Satchand Line, 132kV Belonia - Sabroom Line & associated distribution lines

Date- 26.09.2014

Venue- SATCHAND

Sl. no.	Name of the Present Villager	Name of Village/Address	Work/Profession	Sign.
71	Sh. Partha Debbrishay	N. Patorei	Member	[Signature]
72	" Khitish Ch. Das.	N. Goratate	- Do -	Khitish Ch. Das
73	" Dulal Das	N. Harina	- Do -	Dulal Das
74	Smt. Shipra Kuri (Wah)	B-K. Pally	- Do -	Shipra Kuri (Wah)
75	" Rakhi Das	- Do -	- Do -	Rakhi Das
76	" Sukla Debnath	- Do -	- Do -	Sukla Debnath
77	" Omkar Ch Das	- Do -	- Do -	Omkar Ch Das
78	" Bishupal Paul	- Do -	- Do -	Bishupal Paul
79	Smt. Lakshmi Basak	Dandama	- Do -	Lakshmi Basak
80	" Anu Mazumdar (Bani K)	- Do -	- Do -	Anu Bani K
81	Sanjoy Choudhury	Sureth Bhanuwal	- Do -	Sanjoy Choudh.
82	Sanjoy D/nath	- Do -	- Do -	Sanjoy Debnath

TRIPURA STATE ELECTRICITY CORPORATION LTD
(A GOVERNMENT OF TRIPURA ENTERPRISE)



Public Consultation Meeting
ATTENDANCE SHEET

Name of Line:- Construction of 132kV Bagafa- Satchand Line, 132kV Belonia - Sabroom Line & associated distribution lines

Date- 26.09.2014

Venue- SATCHAND

Sl. no.	Name of the Present Villager	Name of Village/Address	Work/Profession	Sign.
83	Sh. Parimal Debnath	Rajibnagar.	Member -	Parimal Debnath
84	Smt - Jyotsna Chakrabarty	Kalochara.	- DO -	Jyotsna Chakrabarty (Bhatta Chakrabarty)
85	Sh. Jayanta Bhosmik	Battala	- DO -	Jayanta Bhosmik
86	" Shibu Rajan Das	- DO -	"	Sibu R. Das
87	" Parwan Nana	N. Dalakar.	"	Parwan Nana
88	" Tapam Majumdar	Battala	"	Tapam Majumdar
89	Smt - Maya Rani Nath	- DO -	"	Maya Rani Nath
90	" Bebi Rani Das	Battala	"	Bebi Rani Das
91	" Renuka Das	- DO -	"	Renuka Das
92	" Putul Das	Jalapa.	"	Putul Das
93	" Parimal Shill	B. Jalapa.	Pradhan	Parimal Shill
94	Smt - Jayanti Tripura	- DO -	Member -	Jayanti Tripura

TRIPURA STATE ELECTRICITY CORPORATION LTD
(A GOVERNMENT OF TRIPURA ENTERPRISE)



Public Consultation Meeting
ATTENDENCE SHEET

Name of Line:- Construction of 132kV Bagafa- Satchand Line, 132kV Belonia - Sabroom Line & associated distribution lines

Date- 26.09.2014

Venue- SATCHAND

Sl. no.	Name of the Present Villager	Name of Village/Address	Work/Profession	Sign.
95	Smt - Ratna Sharma	E-Jalapa	member.	Ratna Sharma
96	Sh. Jahar Lal Sarkar	Nandigram	- do -	Jahar Lal Sarkar
97	" Gananjoy Debnath	Rajibnagar	do -	Gananjoy Debnath
98	" Amar Ch. Das	Sukanta Patha	- do -	Amar Ch. Das
99	" Narayan Debnath	- do -	"	Narayan Debnath
100	" Chintan Kumar Das	- do -	Pradhan	Chintan Kumar Das
101	Smt - Shikha Das (Majumdar)	Mojoy nagar	Member.	Shikha Das Majumdar
102	Sh. Bishwanjit Majumdar	- do -	"	Bishwanjit Majumdar
103	" Rajib Sarkar	- do -	"	Rajib Sarkar
104	" Babatosh Majumdar	- do -	"	Babatosh Majumdar
105	Smt Madhu Sarkar	- do -	"	Madhu Sarkar
106	" Rina Sutradhar	- do -	"	Rina Sutradhar

PLATE - 1

PUBLIC CONSULTATION PHOTOGRAPHS

Photographs of Public Consultation held on 15th Sep'2014 at Bagafa



Photographs of Public Consultation held on 20th Sep'2014 at Udaipur



Photographs of Public Consultation held on 26th Sep'2014 at Satchand



ANNEXURE - 10
CONTENTS OF FEAR

Contents for Final Environment Assessment Report (FEAR) for Transmission and Distribution Project

Section - I: Project Description: Brief description of the background, objective of the project, resultant benefit and scope of the work.

Section – II: Baseline Data: Description of the relevant physical, physiographical, and socio-economic condition of the project area including description of natural resources base like forest resources or any other environment sensitive areas like National Park sanctuary etc. along with description of climatic condition, population and other demographic features of the project area.

Section -III: Policy, Legal and Regulatory Framework: Description of the policy, Legal and Regulatory framework applicable to transmission project and the environmental requirement under which environment assessment has been carried out.

Section – IV: Major Features of Final Route & Environment Impact: Brief description of the environmental criteria for selection of route and major features of final route alignment, details of forest involvement including number of trees and species of the trees likely to be effected. The details of forest clearance and environmental impact matrix describing in brief the extent of impact of transmission line.

Section – V: Potential Environmental Impact, Evaluation and its Management: Description of the measures adopted and under implementation for identified impact due to project location, design, construction, O&M details of public consultation and its documentation, details of contractual conditions regarding safeguard issues under scope of contract for compliance and conclusion listing the category of the project based on the impact and analysis.

Section – VI: Monitoring and Organization Support Structure: Description of the monitoring plan, reporting pattern/frequency, external monitoring requirement/timing for potential environment & social issues with compliance status of Environment Management Plan (EMP) and organization support structure.

Enclosures:

- 1) Original Topo / GIS map with Final route marked
- 2) Public Consultation details like list of participants, photos etc.
- 3) Copy of Forest proposal and Compensatory Afforestation plan.
- 4) Forest approval letters
- 5) Tree, Crop & Tower footing compensation details
- 6) Contract conditions regarding safeguard issues.
- 7) Budget/Expenditure
- 8) Compliance details of safety checklist/measures

ANNEXURE - 11
BUDGET ESTIMATE

BUDGET ESTIMATE TOWARDS FOREST AND CROP/TREE/ TOWER FOOTING COMPENSATION

Total 132 kV T/L length - 139.3 Kms.
Total 132 kV tower locations - 420 approx.

A. Compensation

1 Forest - Rs. 2845.00 lakhs.

2. Crop & Trees

- 132 kV T/L length in Private /Revenue land –85.27 Kms.

- Crop/tree compensation 132 kV line- (85.27 kms @ 5,00,000/-) - Rs. 426.35 lakhs

3. Land compensation for 132 kV tower footing- (256 towers x 13,600/-) - Rs 34.81 lakhs

Sub Total - A (1+2+3) - Rs. 3306.16 lakhs

B. Implementation Monitoring & Audit

- i) Man-power involved for EMP implementation & Monitoring in entire route of transmission Line (Rs.10, 000/- x 140Km) = Rs. 14.00 lakhs
- ii) Independent Audit (LS) if needed = Rs. 20.00 lakhs

Sub Total - B - Rs. 34.00 lakhs

GrandTotal (A+B) = Rs. 3340.16 lakhs